



**ALLIED MACHINE
& ENGINEERING**

WOHLHAUPTER®

Holemaking Solutions for Today's Manufacturing



Boring



Reaming



Burnishing



Threading

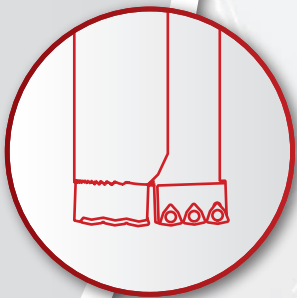

Specials



Revolution Drill®

► *DRILLING*

Indexable Insert Drilling System

SECTION

A60

Revolution Drill®

Revolution Drill®

Large Diameter Replaceable IC Insert Drilling System

► **Diameter Range:** 47.63 mm - 101.60 mm (1.875" - 4.000")



Large Scale Innovation

The Revolution Drill has an innovative design that allows for adjustability of 5.1 mm (0.200") on diameter. This eliminates the need for special tooling and/or subsequent boring operations. With the ability to drill from solid, the Revolution Drill does not require a previously drilled pilot hole. The replaceable cartridges reduce setup time, and the indexable inserts protect your investment. The insert design provides excellent chip control and aggressive penetration rates.

Drills from solid	Drill depths up to 4.5xD	Excellent chip control
-------------------	--------------------------	------------------------

Applicable Industries



Aerospace



Agriculture



Automotive



Firearms



General Machining



Oil & Gas



Renewable Energy

Your safety and the safety of others is very important. This catalogue contains important safety messages. Always read and follow all safety precautions.



This triangle is a safety hazard symbol. It alerts you to potential safety hazards that can cause tool failure and serious injury.

When you see this symbol in the catalogue, look for a related safety message that may be near this triangle or referred to in the nearby text.

There are safety signal words also used in the catalogue. Safety messages follow these words.

WARNING

WARNING (shown above) means that failure to follow the precautions in this message could result in tool failure and serious injury.

NOTICE means that failure to follow the precautions in this message could result in damage to the tool or machine but not result in personal injury.

NOTE and **IMPORTANT** are also used. These are important that you read and follow but are not safety-related.

Visit www.alliedmachine.com for the most up-to-date information and procedures.

Reference Icons

The following icons will appear throughout the catalogue to help you navigate between products.



Setup / Assembly Information

Detailed instructions and information regarding the corresponding part(s)

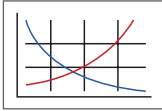

Recommended Cutting Data

Speed and feed recommendations for optimum and safe drilling



Through Coolant Option

Indicates that the product is through coolant

Series	Diameter Range	
	Metric (mm)	Imperial (inch)
34	47.63 - 50.80	1.875 - 2.000
36	50.80 - 55.88	2.000 - 2.200
38	55.88 - 60.96	2.200 - 2.400
42	60.96 - 66.04	2.400 - 2.600
44	66.04 - 71.12	2.600 - 2.800
46	71.12 - 76.20	2.800 - 3.000
48	76.20 - 81.28	3.000 - 3.200
52	81.28 - 86.36	3.200 - 3.400
54	86.36 - 91.44	3.400 - 3.600
56	91.44 - 96.52	3.600 - 3.800
58	96.52 - 101.60	3.800 - 4.000

Introduction Information

Product Overview	2 - 3
Setup Instructions	4
Product Nomenclature	5

Drill Series

34 Series	6 - 7
36 Series	8 - 9
38 Series	10 - 11
42 Series	12 - 13
44 Series	14 - 15
46 Series	16 - 17
48 Series	18 - 19
52 Series	20 - 21
54 Series	22 - 23
56 Series	24 - 25
58 Series	26 - 27

Recommended Cutting Data

Metric (mm)	28
Imperial (inch)	29

Product Overview

Series	Diameter Range		Length-to-Diameter Ratio	Shank Options			Inserts per Cartridge	Page
	Metric (mm)	Imperial (in)		Straight	CAT40	CAT50		
34	47.63 - 50.80	1.875 - 2.000	2.2, 3.5, 4.5	✓	✓	✓	2	6 - 7
36	50.80 - 55.88	2.000 - 2.200	2.2, 3.5, 4.5	✓	✓	✓	2	8 - 9
38	55.88 - 60.96	2.200 - 2.400	2.2, 3.5, 4.5	✓	✓	✓	2	10 - 11
42	60.96 - 66.04	2.400 - 2.600	2.2, 3.5, 4.5	✓	✓	✓	2	12 - 13
44	66.04 - 71.12	2.600 - 2.800	2.2, 3.5	✓		✓	3	14
46	71.12 - 76.20	2.800 - 3.000	2.2, 3.5	✓		✓	3	15
48	76.20 - 81.28	3.000 - 3.200	1.0, 2.5	✓		✓	3	16
52	81.28 - 86.36	3.200 - 3.400	1.0, 2.5	✓		✓	3	17
54	86.36 - 91.44	3.400 - 3.600	1.0, 2.5	✓		✓	3	18
56	91.44 - 96.52	3.600 - 3.800	1.0, 2.5	✓		✓	4	19
58	96.52 - 101.60	3.800 - 4.000	1.0, 2.5	✓		✓	4	20

NOTE: Stacked plate styles are also available

Features & Benefits

- Adjustability of 5.10 mm (0.200") on diameter
- Drill depths up to 4.5xD (standard)
- The replaceable cartridges protect your investment
- Adjustable diameter reduces inventory and cost
- The insert design allows for excellent chip control and aggressive penetration rates
- No pilot hole needed

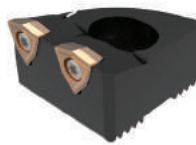

2 Inserts
(34 - 42 series)



3 Inserts
(44 - 54 series)



4 Inserts
(56 - 58 series)

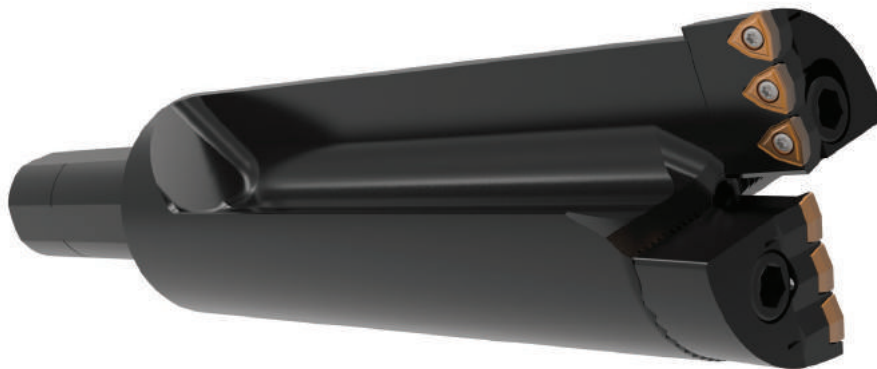

Shank Options

Body Lengths



Straight Shank
(all series)



CAT40 Shank
(34, 36, 38, 42 series)



CAT50 Shank
(all series)

- 1.0xD (48, 52, 54, 56, 58 series)
- 2.2xD (34, 36, 38, 42, 44, 46 series)
- 2.5xD (48, 52, 54, 56, 58 series)
- 3.5xD (34, 36, 38, 42, 44, 46 series)
- 4.5xD (34, 36, 38, 42, 44, 46 series)

A DRILLING

B BORING

C REAMING

D BURNISHING

E THREADING

X SPECIALS

Product Overview

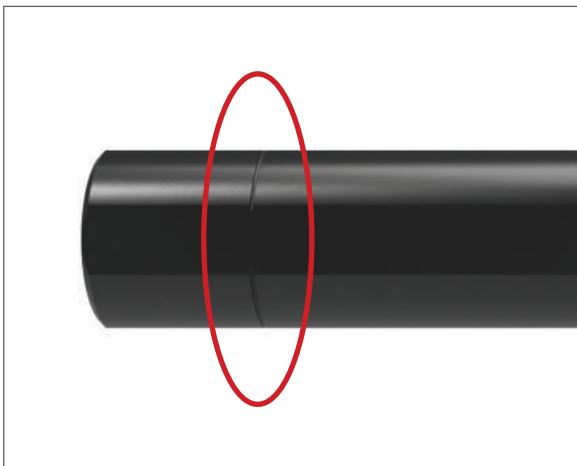
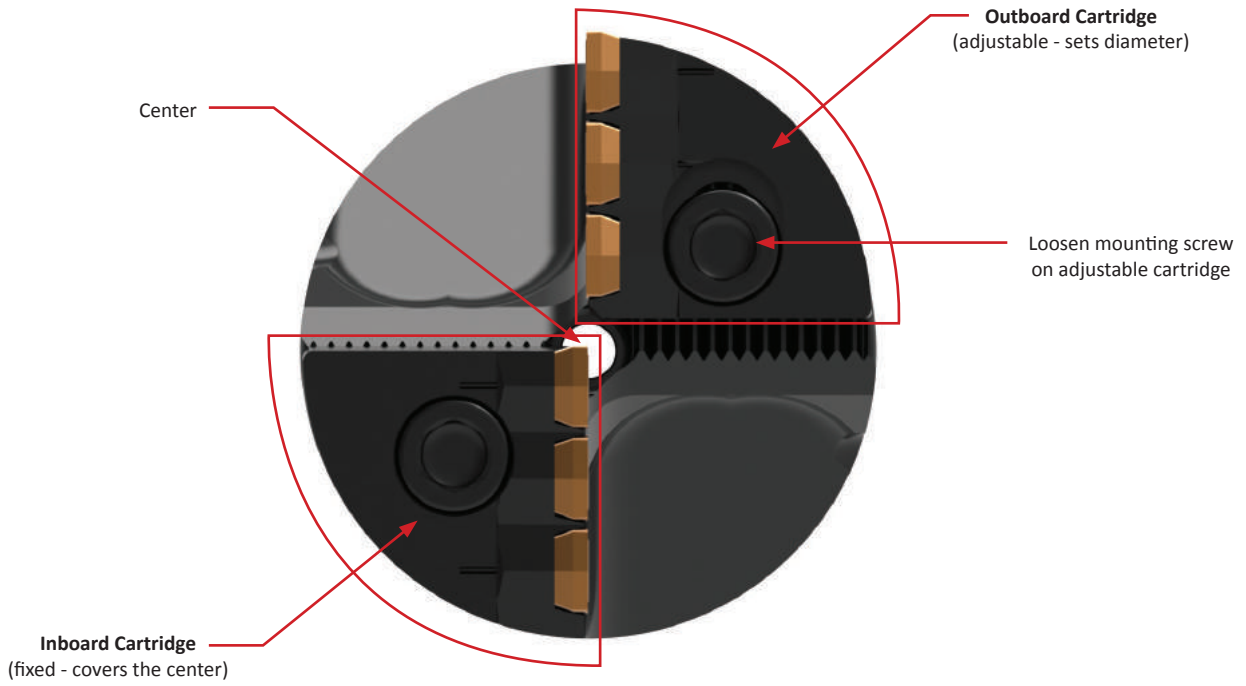

Straight Shanks

- Designed for lathe applications
- Can be cut off for use in end mill holders
- The score mark (circled above) is provided for recommended cut length
- Cut and deburr at the score mark
- This improves rigidity when the body sits against the face of an end mill holder



A
DRILLING
B
BORING
C
REAMING
D
BURNISHING
E
THREADING
X
SPECIALS

Setup Instructions

A
DRILLING
B
BORING
C
REAMING
D
BURNISHING
E
THREADING
X
SPECIALS

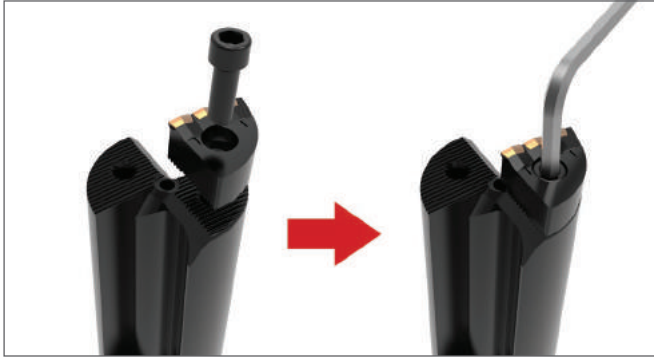

Step 1:
Mount the fixed cartridge and tighten the mounting screw to 15-19 N-m (11-14 ft-lbf).

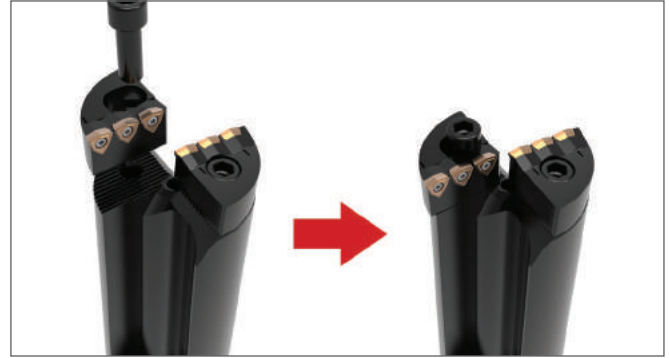

Step 2:
Finger-tighten the mounting screw on the adjustable cartridge.



Step 3:
Set the diameter using the adjustment screw against the mounting screw. Place the drill in a presetter to ensure the correct diameter setting.



Step 4:
Tighten the mounting screw to 15-19 N-m (11-14 ft-lbf).

IC Inserts

- The design allows for excellent chip control and aggressive penetration rates
- The proprietary AM200® and AM300® coatings increase tool life above competitors' premium coatings
- The same inserts are used for both Revolution Drill and Opening Drill® products



AM300®



AM200®



TiN

Insert Application Recommendations

Carbide Grade Options

P35 (C5)	General purpose carbide grade suitable for most applications. ▶ <i>Common application in steels and stainless steels.</i>
K35 (C1)	Toughest carbide grade. Provides the best combination of edge strength and tool life. ▶ <i>Recommended for less rigid applications.</i>
K25 (C2)	Higher wear-resistant carbide suitable for abrasive material applications. ▶ <i>Recommended for grey, ductile, and nodular irons.</i>

Additional Geometry Option

High Rake (HR)	Provides superior chip control and tool life in long chipping carbon and alloy steels below 200 Bhn.
----------------	--

Product Nomenclature

Revolution Drill Holders

R	34	X	22	-	150L
1	2		3		4

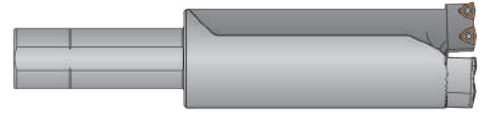

1. Drill Style R = Standard SP = Stacked Plate	2. Series 34 = 34 series 44 = 44 series 54 = 54 series 36 = 36 series 46 = 46 series 56 = 56 series 38 = 38 series 48 = 48 series 58 = 58 series 42 = 42 series 52 = 52 series	3. Length-to-Diameter Ratio 10 = 1.0xD 22 = 2.2xD 25 = 2.5xD 35 = 3.5xD 45 = 4.5xD	4. Shank Information 40M = 40 mm ISO 9766 50M = 50 mm ISO 9766 150L = 1-1/2 Ø straight 200L = 2.0 Ø straight CV40 = CAT40 CV50 = CAT50
---	--	--	---

Revolution Drill Inserts

OP	-	05	T3	08	-	1	H	HR
1		2	3	4		5	6	7

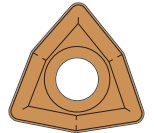

1. Compatible with: Opening Drill® Revolution Drill	2. IC Type 05 = 5/16"	3. Thickness T3 = 5/32"	4. Radius 08 = 1/32"	5. Carbide Grade Blank = P35 (C5) 1 = K35 (C1) 2 = K25 (C2)
6. Coating P = AM300® H = AM200® T = TiN A = TiAlN N = TiCN U = Uncoated	7. Geometry Blank = General Purpose HR = High Rake			

Reference Key

Symbol	Attribute
D_1	Drill diameter range
D_2	Shank diameter
L_1	Overall length
L_2	Maximum drill depth
L_4	Holder length
L_7	Shank length
P_1	Rear pipe tap

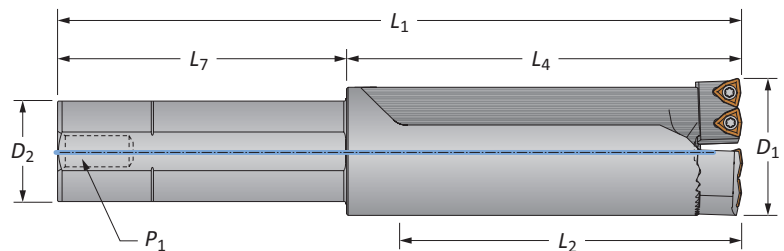

Revolution Drill Holders

34 Series | Diameter Range: 47.63 mm - 50.80 mm (1.875" - 2.000")

A
DRILLING

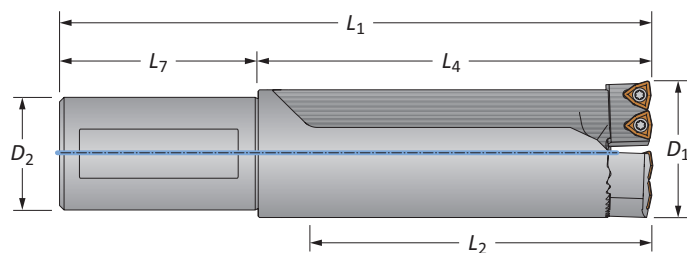

Straight Shank Metric

Style	Length	D ₁ Range	Holder			Shank			Part No.*	Cartridges
			L ₂	L ₄	L ₁	D ₂	L ₇	P ₁		
Standard	2.2xD	47.63 - 50.80	114.94	137.36	207.36	40.00	70.00	-	R34X22-40M	C34-...
Standard	3.5xD	47.63 - 50.80	178.44	200.86	270.86	40.00	70.00	-	R34X35-40M	C34-...
Standard	4.5xD	47.63 - 50.80	229.24	251.66	321.66	40.00	70.00	-	R34X45-40M	C34-...
Stacked Plate	2.2xD	47.63 - 50.80	112.40	134.80	204.80	40.00	70.00	-	SP34X22-40M	C34SP-...

*Holder includes cartridges; however, inserts are sold separately.

C
REAMING

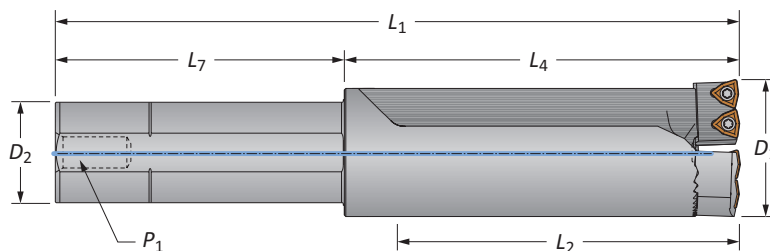

Straight Shank Imperial

Style	Length	D ₁ Range	Holder			Shank			Part No.*	Cartridges
			L ₂	L ₄	L ₁	D ₂	L ₇	P ₁		
Standard	2.2xD	1.875 - 2.000	4-17/32	5-13/32	9-13/32	1-1/2	4	1/4	R34X22-150L	C34-...
Standard	3.5xD	1.875 - 2.000	7-1/32	7-29/32	11-29/32	1-1/2	4	1/4	R34X35-150L	C34-...
Standard	4.5xD	1.875 - 2.000	9-1/32	9-29/32	13-29/32	1-1/2	4	1/4	R34X45-150L	C34-...
Stacked Plate	2.2xD	1.875 - 2.000	4-27/64	5-5/16	9-5/16	1-1/2	4	1/4	SP34X22-150L	C34SP-...

*Holder includes cartridges; however, inserts are sold separately.

F
THREADING

X
SPECIALS

A60: 28 - 29 A60: 2 - 4

Key on A60: 1

m = Metric (mm)
i = Imperial (in)

Revolution Drill Holders

34 Series | Diameter Range: 47.63 mm - 50.80 mm (1.875" - 2.000")

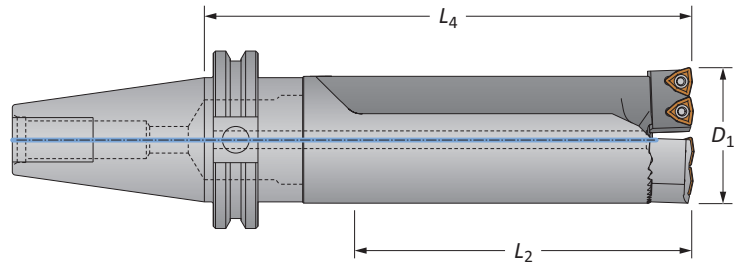

CV40 Shank

Style	Length	D ₁ Range	Holder		Shank	Part No.*	Cartridges
			L ₂	L ₄			
Standard	2.2xD	1.875 - 2.000	4-17/32	6-25/32	CV40	R34X22-CV40	C34-...
Standard	3.5xD	1.875 - 2.000	7-1/32	9-9/32	CV40	R34X35-CV40	C34-...
Standard	4.5xD	1.875 - 2.000	9-1/32	11-9/32	CV40	R34X45-CV40	C34-...
Stacked Plate	2.2xD	1.875 - 2.000	4-27/64	6-11/16	CV40	SP34X22-CV40	C34SP-...

*Holder includes cartridges; however, inserts are sold separately.

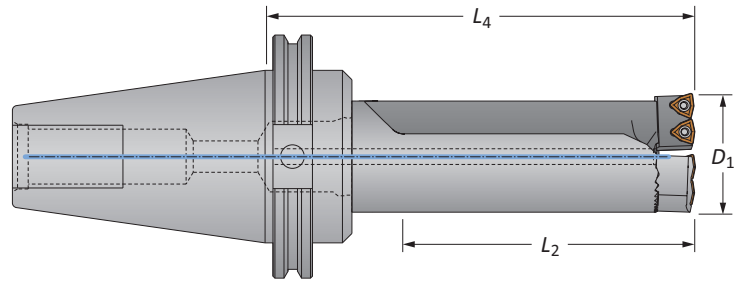

CV50 Shank

Style	Length	D ₁ Range	Holder		Shank	Part No.*	Cartridges
			L ₂	L ₄			
Standard	2.2xD	1.875 - 2.000	4-17/32	6-25/32	CV50	R34X22-CV50	C34-...
Standard	3.5xD	1.875 - 2.000	7-1/32	9-9/32	CV50	R34X35-CV50	C34-...
Standard	4.5xD	1.875 - 2.000	9-1/32	11-9/32	CV50	R34X45-CV50	C34-...
Stacked Plate	2.2xD	1.875 - 2.000	4-27/64	6-11/16	CV50	SP34X22-CV50	C34SP-...

*Holder includes cartridges; however, inserts are sold separately.

Cartridges

Holder Part No.	Replacement Cartridges	Qty. Inserts Needed	Mounting Screw	Key Size	Adjusting Screw	Driver
R34...	C34-FIX	2	MS-17M-1	5 mm	AS-16T9-1	8T-9
	C34-ADJ	2	MS-17M-1	5 mm	AS-16T9-1	8T-9
SP34...	C34SP-FIX	2	MS-17M-1	5 mm	AS-16T9-1	8T-9
	C34SP-ADJ	2	MS-17M-1	5 mm	AS-16T9-1	8T-9

IC Inserts

Carbide Grade	Geometry	Part No.			Insert Screws	Driver
		AM300®	AM200®	TiN		
P35 (C5)	Standard	OP-05T308-P	OP-05T308-H	OP-05T308-T	IS-10-1	8T-9
K35 (C1)	Standard	OP-05T308-1P	OP-05T308-1H	OP-05T308-1T	IS-10-1	8T-9
K25 (C2)	Standard	OP-05T308-2P	OP-05T308-2H	-	IS-10-1	8T-9
P35 (C5)	High Rake	OP-05T308-PHR	OP-05T308-HHR	-	IS-10-1	8T-9

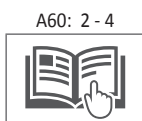
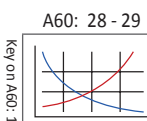

Mounting screws sold in multiples of 4 | Adjusting screws sold in multiples of 4
 IC inserts sold in multiples of 10 | Insert screws sold in multiples of 10

Ⓜ = Metric (mm)
 ⓘ = Imperial (in)

Revolution Drill Holders

36 Series | Diameter Range: 50.80 mm - 55.88 mm (2.000" - 2.200")

A
DRILLING

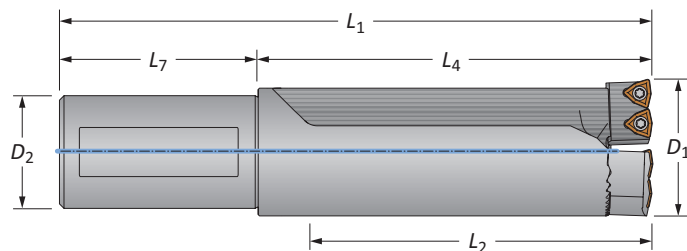

Straight Shank Metric

Style	Length	D ₁ Range	Holder			Shank			Part No.*	Cartridges
			L ₂	L ₄	L ₁	D ₂	L ₇	P ₁		
Standard	2.2xD	50.80 - 55.88	125.96	149.58	219.58	40.00	70.00	-	R36X22-40M	C36-...
Standard	3.5xD	50.80 - 55.88	195.81	219.43	289.43	40.00	70.00	-	R36X35-40M	C36-...
Standard	4.5xD	50.80 - 55.88	252.96	276.58	346.58	40.00	70.00	-	R36X45-40M	C36-...
Stacked Plate	2.2xD	50.80 - 55.88	125.96	147.60	217.60	40.00	70.00	-	SP36X22-40M	C36SP-...

*Holder includes cartridges; however, inserts are sold separately.

C
REAMING

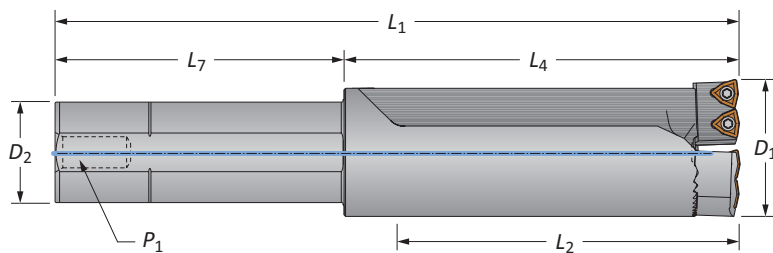

Straight Shank Imperial

Style	Length	D ₁ Range	Holder			Shank			Part No.*	Cartridges
			L ₂	L ₄	L ₁	D ₂	L ₇	P ₁		
Standard	2.2xD	2.000 - 2.200	4-61/64	5-57/64	9-57/64	1-1/2	4	1/4	R36X22-150L	C36-...
Standard	3.5xD	2.000 - 2.200	7-45/64	8-41/64	12-41/64	1-1/2	4	1/4	R36X35-150L	C36-...
Standard	4.5xD	2.000 - 2.200	9-61/64	10-57/64	14-57/64	1-1/2	4	1/4	R36X45-150L	C36-...
Stacked Plate	2.2xD	2.000 - 2.200	4-57/64	5-13/16	9-13/16	1-1/2	4	1/4	SP36X22-150L	C36SP-...

*Holder includes cartridges; however, inserts are sold separately.

D
BURNISHING

F
THREADING

X
SPECIALS

A60: 28 - 29 A60: 2 - 4

Key on A60: 1

M = Metric (mm)
I = Imperial (in)

Revolution Drill Holders

36 Series | Diameter Range: 50.80 mm - 55.88 mm (2.000" - 2.200")

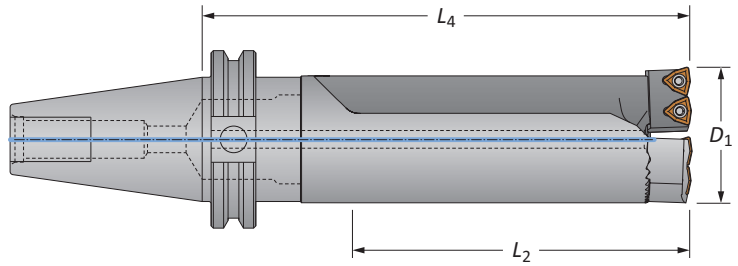

CV40 Shank

Style	Length	D ₁ Range	Holder		Shank	Part No.*	Cartridges
			L ₂	L ₄			
Standard	2.2xD	2.000 - 2.200	4-61/64	7-17/64	CV40	R36X22-CV40	C36-...
Standard	3.5xD	2.000 - 2.200	7-45/64	10-1/64	CV40	R36X35-CV40	C36-...
Standard	4.5xD	2.000 - 2.200	9-61/64	12-17/64	CV40	R36X45-CV40	C36-...
Stacked Plate	2.2xD	2.000 - 2.200	4-57/64	7-35/64	CV40	SP36X22-CV40	C36SP-...

*Holder includes cartridges; however, inserts are sold separately.

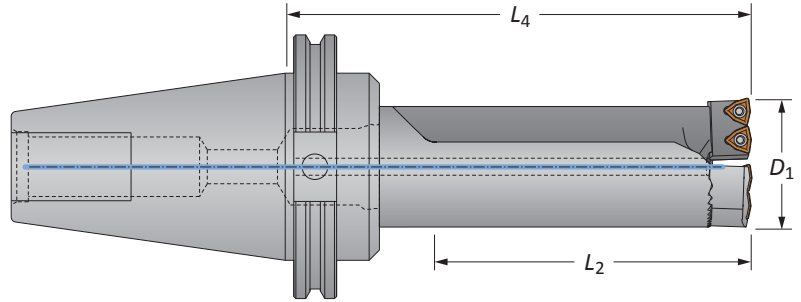

CV50 Shank

Style	Length	D ₁ Range	Holder		Shank	Part No.*	Cartridges
			L ₂	L ₄			
Standard	2.2xD	2.000 - 2.200	4-61/64	7-17/64	CV50	R36X22-CV50	C36-...
Standard	3.5xD	2.000 - 2.200	7-45/64	10-1/64	CV50	R36X35-CV50	C36-...
Standard	4.5xD	2.000 - 2.200	9-61/64	12-17/64	CV50	R36X45-CV50	C36-...
Stacked Plate	2.2xD	2.000 - 2.200	4-57/64	7-35/64	CV50	SP36X22-CV50	C36SP-...

*Holder includes cartridges; however, inserts are sold separately.

Cartridges

Holder Part No.	Replacement Cartridges	Qty. Inserts Needed	Mounting Screw	Key Size	Adjusting Screw	Driver
R36...	C36-FIX	2	MS-17M-1	5 mm	AS-18T9-1	8T-9
	C36-ADJ	2	MS-17M-1	5 mm	AS-18T9-1	8T-9
SP36...	C36SP-FIX	2	MS-17M-1	5 mm	AS-18T9-1	8T-9
	C36SP-ADJ	2	MS-17M-1	5 mm	AS-18T9-1	8T-9

IC Inserts

Carbide Grade	Geometry	Part No.			Insert Screws	Driver
		AM300®	AM200®	TiN		
P35 (C5)	Standard	OP-05T308-P	OP-05T308-H	OP-05T308-T	IS-10-1	8T-9
K35 (C1)	Standard	OP-05T308-1P	OP-05T308-1H	OP-05T308-1T	IS-10-1	8T-9
K25 (C2)	Standard	OP-05T308-2P	OP-05T308-2H	-	IS-10-1	8T-9
P35 (C5)	High Rake	OP-05T308-PHR	OP-05T308-HHR	-	IS-10-1	8T-9

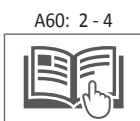
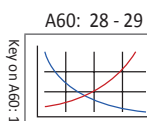

Mounting screws sold in multiples of 4 | Adjusting screws sold in multiples of 4
 IC inserts sold in multiples of 10 | Insert screws sold in multiples of 10

Ⓜ = Metric (mm)
 ⓘ = Imperial (in)

38

 DRILLING | Revolution Drill® Large Diameter Replaceable IC Insert Drilling System

Revolution Drill Holders

38 Series | Diameter Range: 55.88 mm - 60.96 mm (2.200" - 2.400")

 A
DRILLING



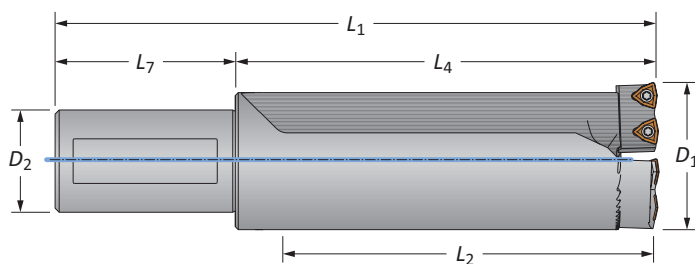

 B
BORING

Straight Shank Metric

Style	Length	D ₁ Range	Holder			Shank			Part No.*	Cartridges
			L ₂	L ₄	L ₁	D ₂	L ₇	P ₁		
Standard	2.2xD	55.88 - 60.96	138.66	162.20	232.20	40.00	70.00	–	R38X22-40M	C38-...
Standard	3.5xD	55.88 - 60.96	214.86	238.40	308.40	40.00	70.00	–	R38X35-40M	C38-...
Standard	4.5xD	55.88 - 60.96	278.36	301.90	371.90	40.00	70.00	–	R38X45-40M	C38-...
Stacked Plate	2.2xD	55.88 - 60.96	138.66	159.99	230.00	40.00	70.00	–	SP38X22-40M	C38SP-...

*Holder includes cartridges; however, inserts are sold separately.

 C
REAMING



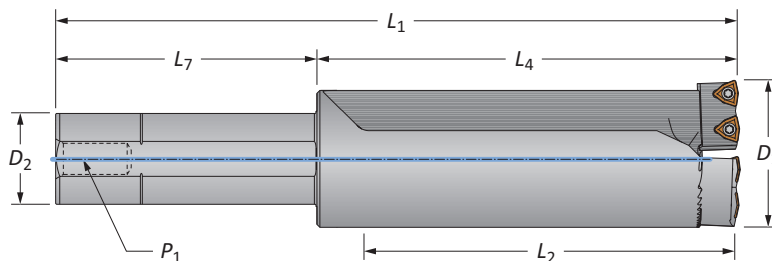

Straight Shank Imperial

Style	Length	D ₁ Range	Holder			Shank			Part No.*	Cartridges
			L ₂	L ₄	L ₁	D ₂	L ₇	P ₁		
Standard	2.2xD	2.200 - 2.400	5-29/64	6-25/64	10-25/64	1-1/2	4	1/4	R38X22-150L	C38-...
Standard	3.5xD	2.200 - 2.400	8-29/64	9-25/64	13-25/64	1-1/2	4	1/4	R38X35-150L	C38-...
Standard	4.5xD	2.200 - 2.400	10-61/64	11-57/64	15-57/64	1-1/2	4	1/4	R38X45-150L	C38-...
Stacked Plate	2.2xD	2.200 - 2.400	5-3/8	6-19/64	10-19/64	1-1/2	4	1/4	SP38X22-150L	C38SP-...

*Holder includes cartridges; however, inserts are sold separately.

 F
THREADING

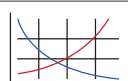
 X
SPECIALS

A60: 28 - 29  Key on A60: 1

A60: 2 - 4 

 m = Metric (mm)
 i = Imperial (in)

A60: 10

www.alliedmachine.com | +44 (0) 1384 400 900 | enquiries.eu@alliedmachine.com

Revolution Drill Holders

38 Series | Diameter Range: 55.88 mm - 60.96 mm (2.200" - 2.400")

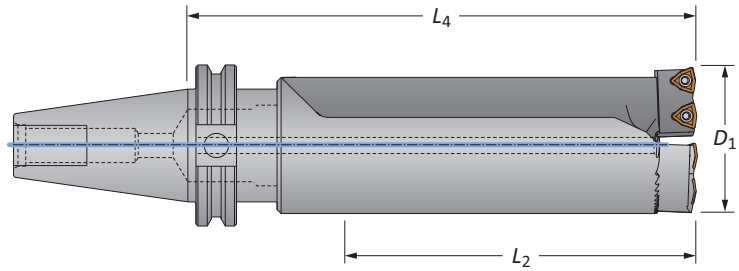

CV40 Shank

Style	Length	D ₁ Range	Holder		Shank	Part No.*	Cartridges
			L ₂	L ₄			
Standard	2.2xD	2.200 - 2.400	5-29/64	7-49/64	CV40	R38X22-CV40	C38-...
Standard	3.5xD	2.200 - 2.400	8-29/64	10-49/64	CV40	R38X35-CV40	C38-...
Standard	4.5xD	2.200 - 2.400	10-61/64	13-17/64	CV40	R38X45-CV40	C38-...
Stacked Plate	2.2xD	2.200 - 2.400	5-3/8	7-43/64	CV40	SP38X22-CV40	C38SP-...

*Holder includes cartridges; however, inserts are sold separately.

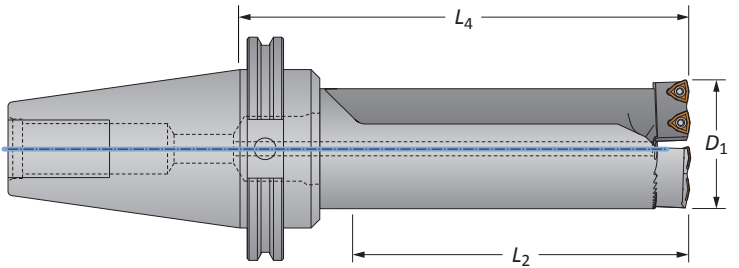

CV50 Shank

Style	Length	D ₁ Range	Holder		Shank	Part No.*	Cartridges
			L ₂	L ₄			
Standard	2.2xD	2.200 - 2.400	5-29/64	7-49/64	CV50	R38X22-CV50	C38-...
Standard	3.5xD	2.200 - 2.400	8-29/64	10-49/64	CV50	R38X35-CV50	C38-...
Standard	4.5xD	2.200 - 2.400	10-61/64	13-17/64	CV50	R38X45-CV50	C38-...
Stacked Plate	2.2xD	2.200 - 2.400	5-3/8	7-43/64	CV50	SP38X22-CV50	C38SP-...

*Holder includes cartridges; however, inserts are sold separately.

Cartridges

Holder Part No.	Replacement Cartridges	Qty. Inserts Needed	Mounting Screw	Key Size	Adjusting Screw	Driver
R38...	C38-FIX	2	MS-17M-1	5 mm	AS-18T9-1	8T-9
	C38-ADJ	2	MS-17M-1	5 mm	AS-18T9-1	8T-9
SP38...	C38SP-FIX	2	MS-17M-1	5 mm	AS-18T9-1	8T-9
	C38SP-ADJ	2	MS-17M-1	5 mm	AS-18T9-1	8T-9

IC Inserts

Carbide Grade	Geometry	Part No.			Insert Screws	Driver
		AM300®	AM200®	TiN		
P35 (C5)	Standard	OP-05T308-P	OP-05T308-H	OP-05T308-T	IS-10-1	8T-9
K35 (C1)	Standard	OP-05T308-1P	OP-05T308-1H	OP-05T308-1T	IS-10-1	8T-9
K25 (C2)	Standard	OP-05T308-2P	OP-05T308-2H	-	IS-10-1	8T-9
P35 (C5)	High Rake	OP-05T308-PHR	OP-05T308-HHR	-	IS-10-1	8T-9

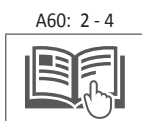
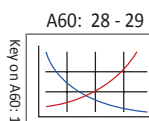

Mounting screws sold in multiples of 4 | Adjusting screws sold in multiples of 4
 IC inserts sold in multiples of 10 | Insert screws sold in multiples of 10

Ⓜ = Metric (mm)
 ⓘ = Imperial (in)

42

 DRILLING | Revolution Drill® Large Diameter Replaceable IC Insert Drilling System

Revolution Drill Holders

42 Series | Diameter Range: 60.96 mm - 66.04 mm (2.400" - 2.600")



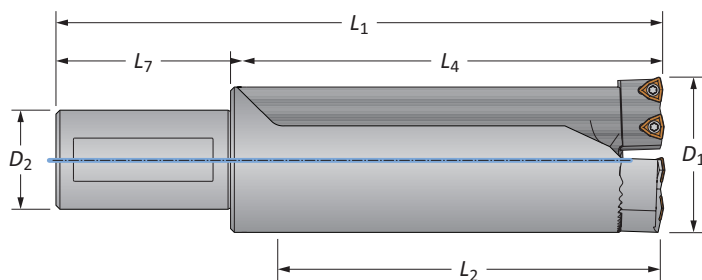

Straight Shank Metric

Style	Length	D ₁ Range	Holder			Shank			Part No.*	Cartridges
			L ₂	L ₄	L ₁	D ₂	L ₇	P ₁		
Standard	2.2xD	60.96 - 66.04	144.88	171.68	241.68	40.00	70.00	–	R42X22-40M	C42-...
Standard	3.5xD	60.96 - 66.04	233.78	260.58	330.58	40.00	70.00	–	R42X35-40M	C42-...
Standard	4.5xD	60.96 - 66.04	297.28	324.08	394.08	40.00	70.00	–	R42X45-40M	C42-...
Stacked Plate	2.2xD	60.96 - 66.04	146.10	172.90	242.90	40.00	70.00	–	SP42X22-40M	C42SP-...

*Holder includes cartridges; however, inserts are sold separately.

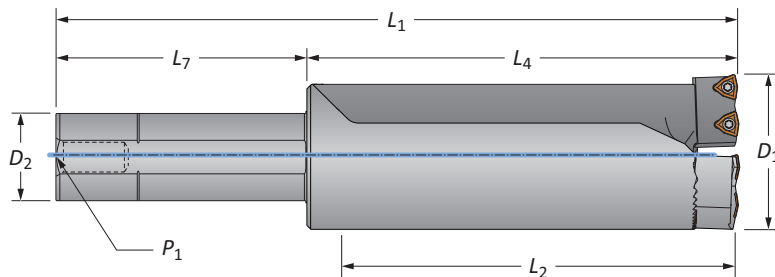

Straight Shank Imperial

Style	Length	D ₁ Range	Holder			Shank			Part No.*	Cartridges
			L ₂	L ₄	L ₁	D ₂	L ₇	P ₁		
Standard	2.2xD	2.400 - 2.600	5-45/64	6-49/64	10-49/64	1-1/2	4	1/4	R42X22-150L	C42-...
Standard	3.5xD	2.400 - 2.600	9-13/64	10-17/64	14-17/64	1-1/2	4	1/4	R42X35-150L	C42-...
Standard	4.5xD	2.400 - 2.600	11-45/64	12-49/64	16-49/64	1-1/2	4	1/4	R42X45-150L	C42-...
Stacked Plate	2.2xD	2.400 - 2.600	5-3/4	6-13/16	10-13/16	1-1/2	4	1/4	SP42X22-150L	C42SP-...

*Holder includes cartridges; however, inserts are sold separately.

A DRILLING

B BORING

C REAMING

D BURNISHING

E THREADING

X SPECIALS

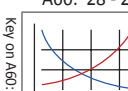
 A60: 28 - 29

 A60: 2 - 4

 M = Metric (mm)
 I = Imperial (in)

A60: 12

www.alliedmachine.com | +44 (0) 1384 400 900 | enquiries.eu@alliedmachine.com

Revolution Drill Holders

42 Series | Diameter Range: 60.96 mm - 66.04 mm (2.400" - 2.600")

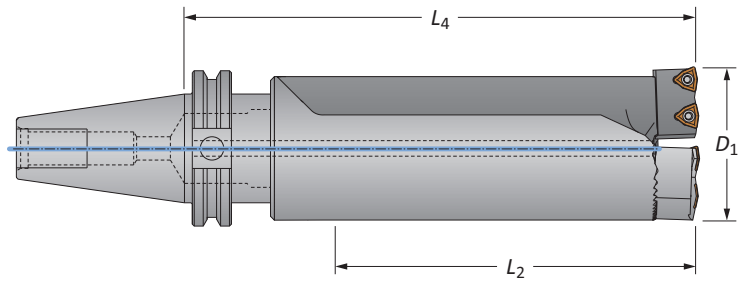

CV40 Shank

Style	Length	D ₁ Range	Holder		Shank	Part No.*	Cartridges
			L ₂	L ₄			
Standard	2.2xD	2.400 - 2.600	5-45/64	8-9/64	CV40	R42X22-CV40	C42-...
Standard	3.5xD	2.400 - 2.600	9-13/64	11-41/64	CV40	R42X35-CV40	C42-...
Standard	4.5xD	2.400 - 2.600	11-45/64	14-9/64	CV40	R42X45-CV40	C42-...
Stacked Plate	2.2xD	2.400 - 2.600	5-3/4	8-3/16	CV40	SP42X22-CV40	C42SP-...

*Holder includes cartridges; however, inserts are sold separately.

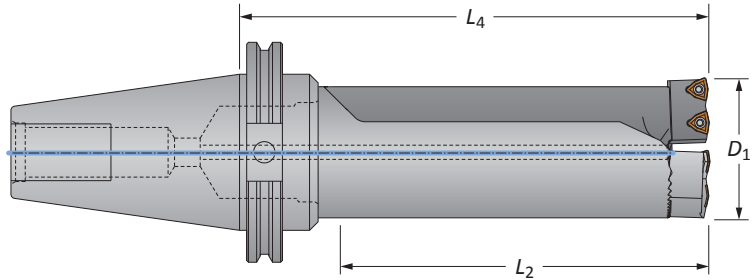

CV50 Shank

Style	Length	D ₁ Range	Holder		Shank	Part No.*	Cartridges
			L ₂	L ₄			
Standard	2.2xD	2.400 - 2.600	5-45/64	8-9/64	CV50	R42X22-CV50	C42-...
Standard	3.5xD	2.400 - 2.600	9-13/64	11-41/64	CV50	R42X35-CV50	C42-...
Standard	4.5xD	2.400 - 2.600	11-45/64	14-9/64	CV50	R42X45-CV50	C42-...
Stacked Plate	2.2xD	2.400 - 2.600	5-3/4	8-3/16	CV50	SP42X22-CV50	C42SP-...

*Holder includes cartridges; however, inserts are sold separately.

Cartridges

Holder Part No.	Replacement Cartridges	Qty. Inserts Needed	Mounting Screw	Key Size	Adjusting Screw	Driver
R42...	C42-FIX	2	MS-19M-1	6 mm	AS-18T9-1	8T-9
	C42-ADJ	2	MS-19M-1	6 mm	AS-18T9-1	8T-9
SP42...	C42SP-FIX	2	MS-19M-1	6 mm	AS-18T9-1	8T-9
	C42SP-ADJ	2	MS-19M-1	6 mm	AS-18T9-1	8T-9

IC Inserts

Carbide Grade	Geometry	Part No.			Insert Screws	Driver
		AM300®	AM200®	TiN		
P35 (C5)	Standard	OP-05T308-P	OP-05T308-H	OP-05T308-T	IS-10-1	8T-9
K35 (C1)	Standard	OP-05T308-1P	OP-05T308-1H	OP-05T308-1T	IS-10-1	8T-9
K25 (C2)	Standard	OP-05T308-2P	OP-05T308-2H	-	IS-10-1	8T-9
P35 (C5)	High Rake	OP-05T308-PHR	OP-05T308-HHR	-	IS-10-1	8T-9

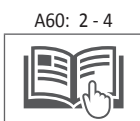
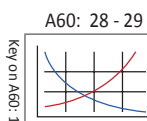

Mounting screws sold in multiples of 4 | Adjusting screws sold in multiples of 4
 IC inserts sold in multiples of 10 | Insert screws sold in multiples of 10

Ⓜ = Metric (mm)
 ⓘ = Imperial (in)

44

 DRILLING | Revolution Drill® Large Diameter Replaceable IC Insert Drilling System

Revolution Drill Holders

44 Series | Diameter Range: 66.04 mm - 71.12 mm (2.600" - 2.800")



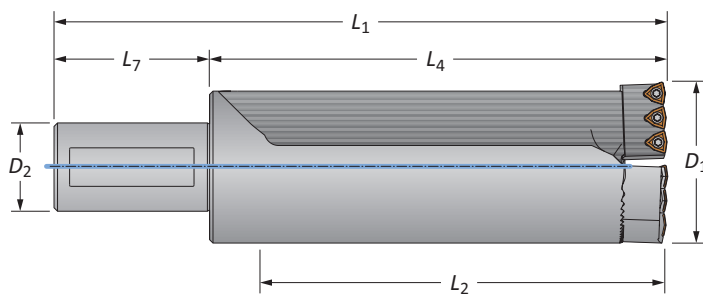

Straight Shank Metric

Style	Length	D ₁ Range	Holder			Shank			Part No.*	Cartridges
			L ₂	L ₄	L ₁	D ₂	L ₇	P ₁		
Standard	2.2xD	66.04 - 71.12	157.63	190.65	260.65	40.00	70.00	–	R44X22-40M	C44-...
Standard	3.5xD	66.04 - 71.12	252.88	285.90	355.90	40.00	70.00	–	R44X35-40M	C44-...
Stacked Plate	2.2xD	66.04 - 71.12	158.70	191.69	261.70	40.00	70.00	–	SP44X22-40M	C44SP-...

*Holder includes cartridges; however, inserts are sold separately.



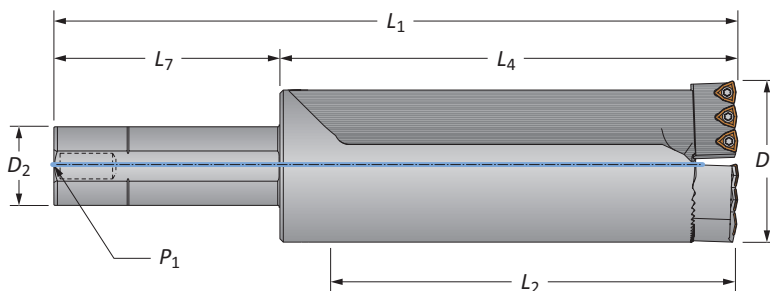



Straight Shank Imperial

Style	Length	D ₁ Range	Holder			Shank			Part No.*	Cartridges
			L ₂	L ₄	L ₁	D ₂	L ₇	P ₁		
Standard	2.2xD	2.600 - 2.800	6-13/64	7-1/2	11-1/2	1-1/2	4	1/4	R44X22-150L	C44-...
Standard	3.5xD	2.600 - 2.800	9-61/64	11-1/4	15-1/4	1-1/2	4	1/4	R44X35-150L	C44-...
Stacked Plate	2.2xD	2.600 - 2.800	6-1/4	7-35/64	11-35/64	1-1/2	4	1/4	SP44X22-150L	C44SP-...

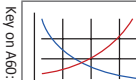
*Holder includes cartridges; however, inserts are sold separately.

A
DRILLINGB
BORINGC
REAMINGD
BURNISHINGE
THREADINGX
SPECIALS
 A60: 28 - 29

 A60: 2 - 4

 M = Metric (mm)
 I = Imperial (in)

A60: 14

www.alliedmachine.com | +44 (0) 1384 400 900 | enquiries.eu@alliedmachine.com

Revolution Drill Holders

44 Series | Diameter Range: 66.04 mm - 71.12 mm (2.600" - 2.800")

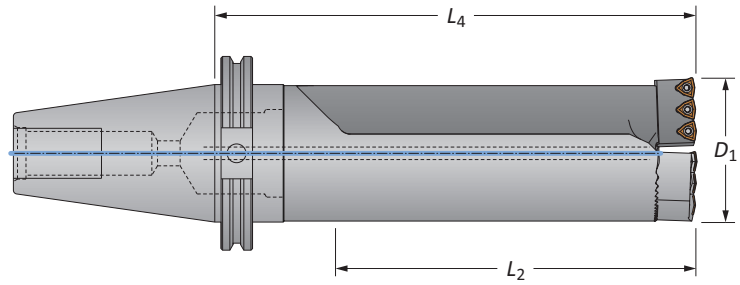

CV50 Shank

Style	Length	D_1 Range	Holder		Shank	Part No.*	Cartridges	
			L_2	L_4				
i	Standard	2.2xD	2.600 - 2.800	6-13/64	8-7/8	CV50	R44X22-CV50	C44-...
	Standard	3.5xD	2.600 - 2.800	9-61/64	12-5/8	CV50	R44X35-CV50	C44-...
	Stacked Plate	2.2xD	2.600 - 2.800	6-1/4	8-59/64	CV50	SP44X22-CV50	C44SP-...

*Holder includes cartridges; however, inserts are sold separately.

Cartridges

Holder Part No.	Replacement Cartridges	Qty. Inserts Needed	Mounting Screw	Key Size	Adjusting Screw	Driver
R44...	C44-FIX	3	MS-19M-1	6 mm	AS-18T9-1	8T-9
	C44-ADJ	3	MS-19M-1	6 mm	AS-18T9-1	8T-9
SP44...	C44SP-FIX	3	MS-19M-1	6 mm	AS-18T9-1	8T-9
	C44SP-ADJ	3	MS-19M-1	6 mm	AS-18T9-1	8T-9

IC Inserts

Carbide Grade	Geometry	Part No.			Insert Screws	Driver
		AM300®	AM200®	TiN		
P35 (C5)	Standard	OP-05T308-P	OP-05T308-H	OP-05T308-T	IS-10-1	8T-9
K35 (C1)	Standard	OP-05T308-1P	OP-05T308-1H	OP-05T308-1T	IS-10-1	8T-9
K25 (C2)	Standard	OP-05T308-2P	OP-05T308-2H	-	IS-10-1	8T-9
P35 (C5)	High Rake	OP-05T308-PHR	OP-05T308-HHR	-	IS-10-1	8T-9

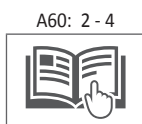
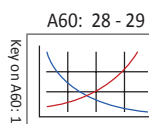

Mounting screws sold in multiples of 4 | Adjusting screws sold in multiples of 4
 IC inserts sold in multiples of 10 | Insert screws sold in multiples of 10

= Metric (mm)
 = Imperial (in)

46

 DRILLING | Revolution Drill® Large Diameter Replaceable IC Insert Drilling System

Revolution Drill Holders

46 Series | Diameter Range: 71.12 mm - 76.20 mm (2.800" - 3.000")



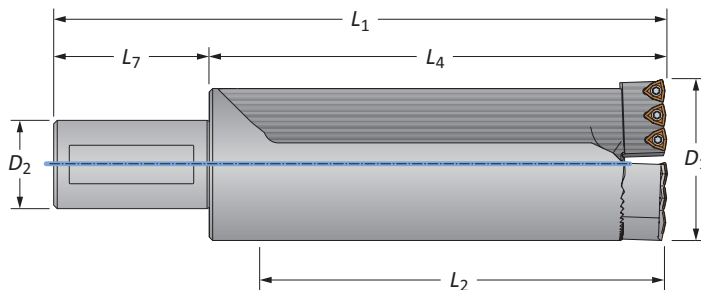

Straight Shank Metric

Style	Length	D_1 Range	Holder			Shank			Part No.*	Cartridges
			L_2	L_4	L_1	D_2	L_7	P_1		
Standard	2.2xD	71.12 - 76.20	170.36	203.38	273.38	40.00	70.00	–	R46X22-40M	C46-...
Standard	3.5xD	71.12 - 76.20	265.61	298.63	368.63	40.00	70.00	–	R46X35-40M	C46-...
Stacked Plate	2.2xD	71.12 - 76.20	171.40	204.39	274.40	40.00	70.00	–	SP46X22-40M	C46SP-...

*Holder includes cartridges; however, inserts are sold separately.



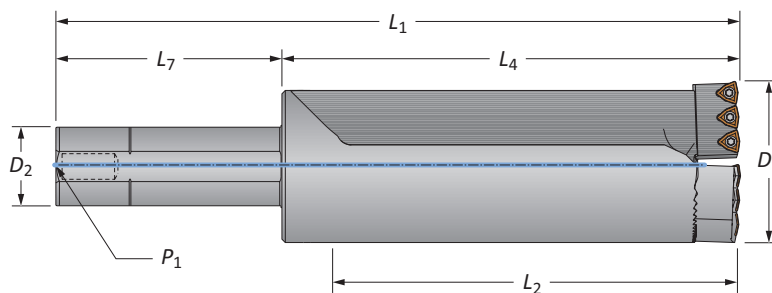

Straight Shank Imperial

Style	Length	D_1 Range	Holder			Shank			Part No.*	Cartridges
			L_2	L_4	L_1	D_2	L_7	P_1		
Standard	2.2xD	2.800 - 3.000	6-45/64	8	12	1-1/2	4	1/4	R46X22-150L	C46-...
Standard	3.5xD	2.800 - 3.000	10-29/64	11-3/4	15-3/4	1-1/2	4	1/4	R46X35-150L	C46-...
Stacked Plate	2.2xD	2.800 - 3.000	6-3/4	8-3/64	12-3/64	1-1/2	4	1/4	SP46X22-150L	C46SP-...

*Holder includes cartridges; however, inserts are sold separately.

A DRILLING

B BORING

C REAMING

D BURNISHING

E THREADING

X SPECIALS

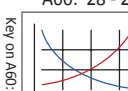
 A60: 28 - 29

 A60: 2 - 4

 M = Metric (mm)
 I = Imperial (in)

A60: 16

www.alliedmachine.com | +44 (0) 1384 400 900 | enquiries.eu@alliedmachine.com

Revolution Drill Holders

46 Series | Diameter Range: 71.12 mm - 76.20 mm (2.800" - 3.000")

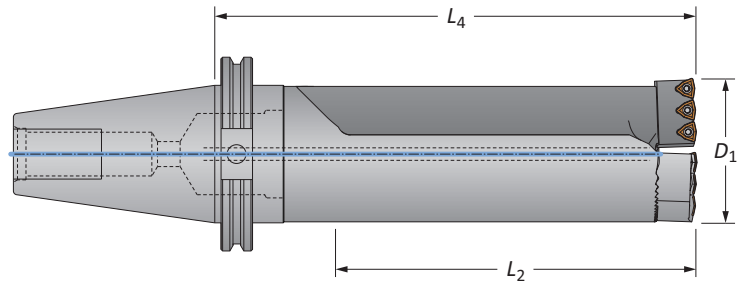

CV50 Shank

Style	Length	D ₁ Range	Holder		Shank	Part No.*	Cartridges	
			L ₂	L ₄				
i	Standard	2.2xD	2.800 - 3.000	6-45/64	9-25/64	CV50	R46X22-CV50	C46-...
	Standard	3.5xD	2.800 - 3.000	10-29/64	13-1/8	CV50	R46X35-CV50	C46-...
	Stacked Plate	2.2xD	2.800 - 3.000	6-3/4	9-27/64	CV50	SP46X22-CV50	C46SP-...

*Holder includes cartridges; however, inserts are sold separately.

Cartridges

Holder Part No.	Replacement Cartridges	Qty. Inserts Needed	Mounting Screw	Key Size	Adjusting Screw	Driver
R46...	C46-FIX	3	MS-21M-1	8 mm	AS-18T9-1	8T-9
	C46-ADJ	3	MS-21M-1	8 mm	AS-18T9-1	8T-9
SP46...	C46SP-FIX	3	MS-21M-1	8 mm	AS-18T9-1	8T-9
	C46SP-ADJ	3	MS-21M-1	8 mm	AS-18T9-1	8T-9

IC Inserts

Carbide Grade	Geometry	Part No.			Insert Screws	Driver
		AM300®	AM200®	TiN		
P35 (C5)	Standard	OP-05T308-P	OP-05T308-H	OP-05T308-T	IS-10-1	8T-9
K35 (C1)	Standard	OP-05T308-1P	OP-05T308-1H	OP-05T308-1T	IS-10-1	8T-9
K25 (C2)	Standard	OP-05T308-2P	OP-05T308-2H	-	IS-10-1	8T-9
P35 (C5)	High Rake	OP-05T308-PHR	OP-05T308-HHR	-	IS-10-1	8T-9

A60: 28 - 29

A60: 2 - 4

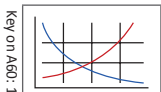

Mounting screws sold in multiples of 4 | Adjusting screws sold in multiples of 4
 IC inserts sold in multiples of 10 | Insert screws sold in multiples of 10

= Metric (mm)
 = Imperial (in)

Revolution Drill Holders

48 Series | Diameter Range: 76.20 mm - 81.28 mm (3.000" - 3.200")

A DRILLING

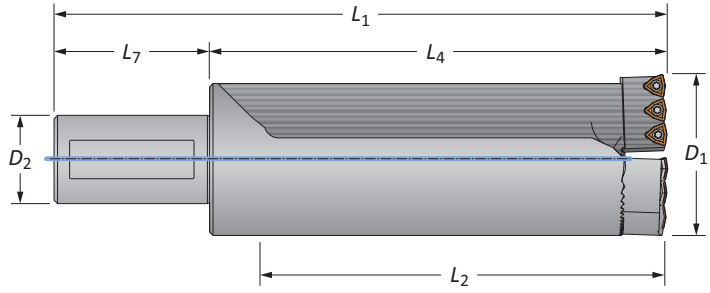

B BORING

Straight Shank Metric

Style	Length	D ₁ Range	Holder			Shank			Part No.*	Cartridges
			L ₂	L ₄	L ₁	D ₂	L ₇	P ₁		
Standard	1.0xD	76.20 - 81.28	80.21	114.50	194.50	50.00	80.00	-	R48X10-50M	C48-...
Standard	2.5xD	76.20 - 81.28	200.86	235.15	315.15	50.00	80.00	-	R48X25-50M	C48-...
Stacked Plate	1.0xD	76.20 - 81.28	80.21	116.51	196.52	50.00	80.00	-	SP48X10-50M	C48SP-...
Stacked Plate	2.5xD	76.20 - 81.28	200.86	237.21	317.22	50.00	80.00	-	SP48X25-50M	C48SP-...

*Holder includes cartridges; however, inserts are sold separately.

C REAMING

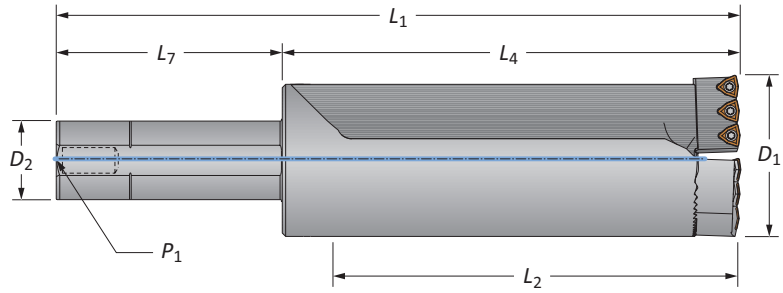

D BURNISHING

Straight Shank Imperial

Style	Length	D ₁ Range	Holder			Shank			Part No.*	Cartridges
			L ₂	L ₄	L ₁	D ₂	L ₇	P ₁		
Standard	1.0xD	3.000 - 3.200	3-5/32	4-33/64	9-1/64	2	4-1/2	1/4	R48X10-200L	C48-...
Standard	2.5xD	3.000 - 3.200	7-29/32	9-17/64	13-49/64	2	4-1/2	1/4	R48X25-200L	C48-...
Stacked Plate	1.0xD	3.000 - 3.200	3-15/64	4-19/32	9-3/32	2	4-1/2	1/4	SP48X10-200L	C48SP-...
Stacked Plate	2.5xD	3.000 - 3.200	7-63/64	9-11/32	13-27/32	2	4-1/2	1/4	SP48X25-200L	C48SP-...

*Holder includes cartridges; however, inserts are sold separately.

F THREADING

X SPECIALS

A60: 28 - 29 A60: 2 - 4

Key on A60: 1

Ⓜ = Metric (mm)
Ⓡ = Imperial (in)

Revolution Drill Holders

48 Series | Diameter Range: 76.20 mm - 81.28 mm (3.000" - 3.200")

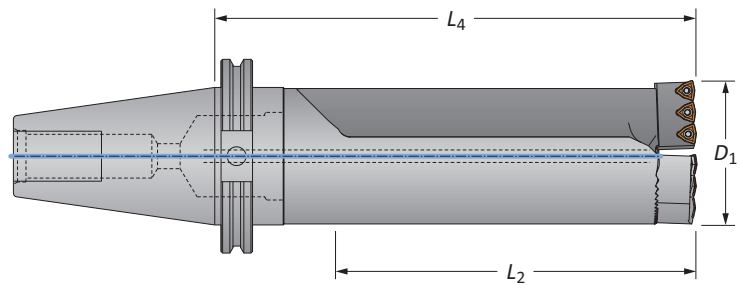

CV50 Shank

Style	Length	D ₁ Range	Holder		Shank	Part No.*	Cartridges	
			L ₂	L ₄				
i	Standard	1.0xD	3.000 - 3.200	3-5/32	5-57/64	CV50	R48X10-CV50	C48-...
	Standard	2.5xD	3.000 - 3.200	7-29/32	10-41/64	CV50	R48X25-CV50	C48-...
	Stacked Plate	1.0xD	3.000 - 3.200	3-15/64	5-31/32	CV50	SP48X10-CV50	C48SP-...
	Stacked Plate	2.5xD	3.000 - 3.200	7-63/64	10-23/32	CV50	SP48X25-CV50	C48SP-...

*Holder includes cartridges; however, inserts are sold separately.

Cartridges

Holder Part No.	Replacement Cartridges	Qty. Inserts Needed	Mounting Screw	Key Size	Adjusting Screw	Driver
R48...	C48-FIX	3	MS-21M-1	8 mm	AS-18T9-1	8T-9
	C48-ADJ	3	MS-21M-1	8 mm	AS-18T9-1	8T-9
SP48...	C48SP-FIX	3	MS-21M-1	8 mm	AS-18T9-1	8T-9
	C48SP-ADJ	3	MS-21M-1	8 mm	AS-18T9-1	8T-9

IC Inserts

Carbide Grade	Geometry	Part No.			Insert Screws	Driver
		AM300®	AM200®	TiN		
P35 (C5)	Standard	OP-05T308-P	OP-05T308-H	OP-05T308-T	IS-10-1	8T-9
K35 (C1)	Standard	OP-05T308-1P	OP-05T308-1H	OP-05T308-1T	IS-10-1	8T-9
K25 (C2)	Standard	OP-05T308-2P	OP-05T308-2H	-	IS-10-1	8T-9
P35 (C5)	High Rake	OP-05T308-PHR	OP-05T308-HHR	-	IS-10-1	8T-9

A60: 28 - 29

Key on A60: 1

A60: 2 - 4

Mounting screws sold in multiples of 4 | Adjusting screws sold in multiples of 4
 IC inserts sold in multiples of 10 | Insert screws sold in multiples of 10

= Metric (mm)
 = Imperial (in)

52

 DRILLING | Revolution Drill® Large Diameter Replaceable IC Insert Drilling System

Revolution Drill Holders

52 Series | Diameter Range: 81.28 mm - 86.36 mm (3.200" - 3.400")



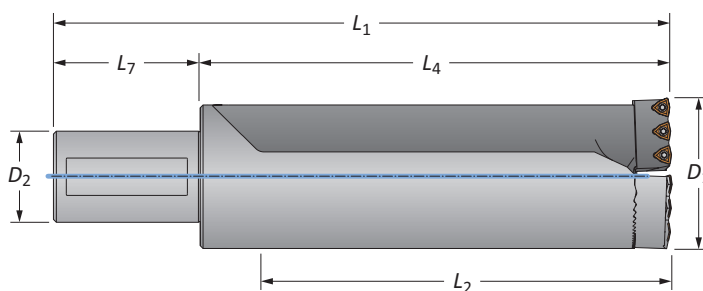

Straight Shank Metric

Style	Length	D ₁ Range	Holder			Shank			Part No.*	Cartridges
			L ₂	L ₄	L ₁	D ₂	L ₇	P ₁		
Standard	1.0xD	81.28 - 86.36	86.72	127.23	207.23	50.00	80.00	–	R52X10-50M	C52-...
Standard	2.5xD	81.28 - 86.36	213.72	254.02	334.02	50.00	80.00	–	R52X25-50M	C52-...
Stacked Plate	1.0xD	81.28 - 86.36	88.60	129.11	209.12	50.00	80.00	–	SP52X10-50M	C52SP-...
Stacked Plate	2.5xD	81.28 - 86.36	215.60	256.11	336.12	50.00	80.00	–	SP52X25-50M	C52SP-...

*Holder includes cartridges; however, inserts are sold separately.

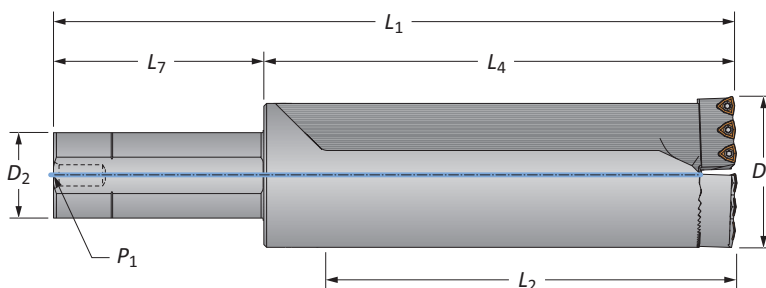

Straight Shank Imperial

Style	Length	D ₁ Range	Holder			Shank			Part No.*	Cartridges
			L ₂	L ₄	L ₁	D ₂	L ₇	P ₁		
Standard	1.0xD	3.200 - 3.400	3-27/64	5-1/64	9-33/64	2	4-1/2	1/4	R52X10-200L	C52-...
Standard	2.5xD	3.200 - 3.400	8-27/64	10-1/64	14-33/64	2	4-1/2	1/4	R52X25-200L	C52-...
Stacked Plate	1.0xD	3.200 - 3.400	3-31/64	5-5/64	9-37/64	2	4-1/2	1/4	SP52X10-200L	C52SP-...
Stacked Plate	2.5xD	3.200 - 3.400	8-31/64	10-5/64	14-37/64	2	4-1/2	1/4	SP52X25-200L	C52SP-...

*Holder includes cartridges; however, inserts are sold separately.

A DRILLING

B BORING

C REAMING

D BURNISHING

E THREADING

X SPECIALS

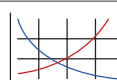
 A60: 28 - 29
 Key on A60: 1

 A60: 2 - 4

 M = Metric (mm)
 I = Imperial (in)

A60: 20

www.alliedmachine.com | +44 (0) 1384 400 900 | enquiries.eu@alliedmachine.com

Revolution Drill Holders

52 Series | Diameter Range: 81.28 mm - 86.36 mm (3.200" - 3.400")

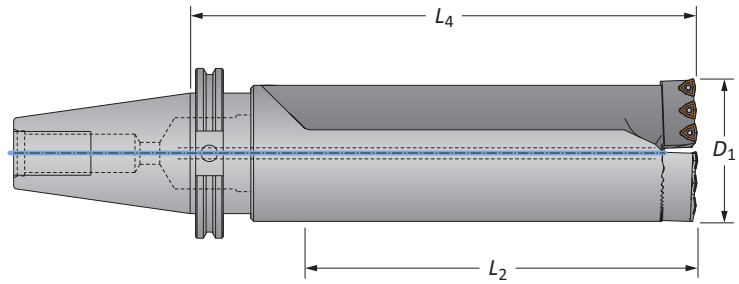

CV50 Shank

Style	Length	D ₁ Range	Holder		Shank	Part No.*	Cartridges	
			L ₂	L ₄				
i	Standard	1.0xD	3.200 - 3.400	3-27/64	6-25/64	CV50	R52X10-CV50	C52-...
	Standard	2.5xD	3.200 - 3.400	8-27/64	11-25/64	CV50	R52X25-CV50	C52-...
	Stacked Plate	1.0xD	3.200 - 3.400	3-31/64	6-29/64	CV50	SP52X10-CV50	C52SP-...
	Stacked Plate	2.5xD	3.200 - 3.400	8-31/64	11-29/64	CV50	SP52X25-CV50	C52SP-...

*Holder includes cartridges; however, inserts are sold separately.

Cartridges

Holder Part No.	Replacement Cartridges	Qty. Inserts Needed	Mounting Screw	Key Size	Adjusting Screw	Driver
R52...	C52-FIX	3	MS-19M-1	6 mm	AS-18T9-1	8T-9
	C52-ADJ	3	MS-19M-1	6 mm	AS-18T9-1	8T-9
SP52...	C52SP-FIX	3	MS-19M-1	6 mm	AS-18T9-1	8T-9
	C52SP-ADJ	3	MS-19M-1	6 mm	AS-18T9-1	8T-9

IC Inserts

Carbide Grade	Geometry	Part No.			Insert Screws	Driver
		AM300®	AM200®	TiN		
P35 (C5)	Standard	OP-05T308-P	OP-05T308-H	OP-05T308-T	IS-10-1	8T-9
K35 (C1)	Standard	OP-05T308-1P	OP-05T308-1H	OP-05T308-1T	IS-10-1	8T-9
K25 (C2)	Standard	OP-05T308-2P	OP-05T308-2H	-	IS-10-1	8T-9
P35 (C5)	High Rake	OP-05T308-PHR	OP-05T308-HHR	-	IS-10-1	8T-9

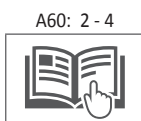
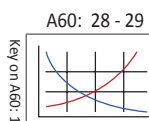

Mounting screws sold in multiples of 4 | Adjusting screws sold in multiples of 4
 IC inserts sold in multiples of 10 | Insert screws sold in multiples of 10

= Metric (mm)
 = Imperial (in)

Revolution Drill Holders

54 Series | Diameter Range: 86.36 mm - 91.44 mm (3.400" - 3.600")

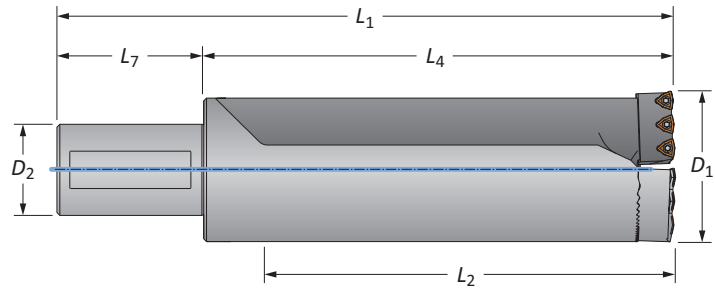

Straight Shank Metric

Style	Length	D_1 Range	Holder			Shank			Part No.*	Cartridges
			L_2	L_4	L_1	D_2	L_7	P_1		
Standard	1.0xD	86.36 - 91.44	92.94	133.58	213.58	50.00	80.00	-	R54X10-50M	C54-...
Standard	2.5xD	86.36 - 91.44	226.29	266.93	346.93	50.00	80.00	-	R54X25-50M	C54-...
Stacked Plate	1.0xD	86.36 - 91.44	94.50	135.10	215.10	50.00	80.00	-	SP54X10-50M	C54SP-...
Stacked Plate	2.5xD	86.36 - 91.44	227.81	268.50	348.51	50.00	80.00	-	SP54X25-50M	C54SP-...

*Holder includes cartridges; however, inserts are sold separately.

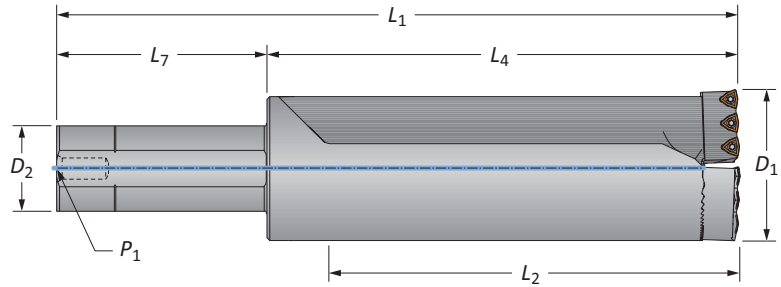

Straight Shank Imperial

Style	Length	D_1 Range	Holder			Shank			Part No.*	Cartridges
			L_2	L_4	L_1	D_2	L_7	P_1		
Standard	1.0xD	3.400 - 3.600	3-21/32	5-17/64	9-49/64	2	4-1/2	1/4	R54X10-200L	C54-...
Standard	2.5xD	3.400 - 3.600	8-29/32	10-33/64	15-1/64	2	4-1/2	1/4	R54X25-200L	C54-...
Stacked Plate	1.0xD	3.400 - 3.600	3-23/32	5-21/64	9-53/64	2	4-1/2	1/4	SP54X10-200L	C54SP-...
Stacked Plate	2.5xD	3.400 - 3.600	8-31/32	10-37/64	15-5/64	2	4-1/2	1/4	SP54X25-200L	C54SP-...

*Holder includes cartridges; however, inserts are sold separately.



A
DRILLINGB
BORINGC
REAMINGD
BURNISHINGE
THREADINGX
SPECIALS

A60: 28 - 29

A60: 2 - 4

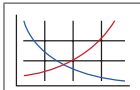
Key on A60: 1



 = Metric (mm)
 = Imperial (in)

Revolution Drill Holders

54 Series | Diameter Range: 86.36 mm - 91.44 mm (3.400" - 3.600")

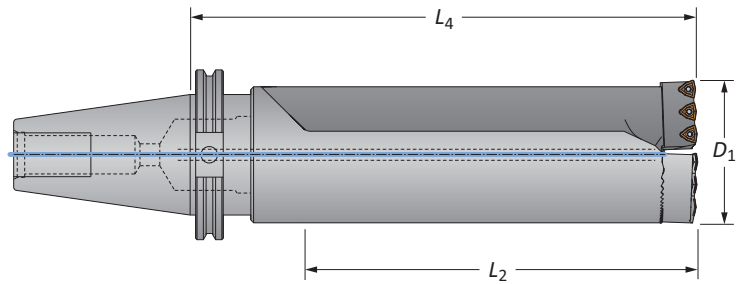

CV50 Shank

Style	Length	D ₁ Range	Holder		Shank	Part No.*	Cartridges	
			L ₂	L ₄				
i	Standard	1.0xD	3.400 - 3.600	3-21/32	6-41/64	CV50	R54X10-CV50	C54-...
	Standard	2.5xD	3.400 - 3.600	8-29/32	11-57/64	CV50	R54X25-CV50	C54-...
	Stacked Plate	1.0xD	3.400 - 3.600	3-23/32	6-11/16	CV50	SP54X10-CV50	C54SP-...
	Stacked Plate	2.5xD	3.400 - 3.600	8-31/32	11-15/16	CV50	SP54X25-CV50	C54SP-...

*Holder includes cartridges; however, inserts are sold separately.

Cartridges

Holder Part No.	Replacement Cartridges	Qty. Inserts Needed	Mounting Screw	Key Size	Adjusting Screw	Driver
R54...	C54-FIX	3	MS-19M-1	6 mm	AS-18T9-1	8T-9
	C54-ADJ	3	MS-19M-1	6 mm	AS-18T9-1	8T-9
SP54...	C54SP-FIX	3	MS-19M-1	6 mm	AS-18T9-1	8T-9
	C54SP-ADJ	3	MS-19M-1	6 mm	AS-18T9-1	8T-9

IC Inserts

Carbide Grade	Geometry	Part No.			Insert Screws	Driver
		AM300®	AM200®	TiN		
P35 (C5)	Standard	OP-05T308-P	OP-05T308-H	OP-05T308-T	IS-10-1	8T-9
K35 (C1)	Standard	OP-05T308-1P	OP-05T308-1H	OP-05T308-1T	IS-10-1	8T-9
K25 (C2)	Standard	OP-05T308-2P	OP-05T308-2H	-	IS-10-1	8T-9
P35 (C5)	High Rake	OP-05T308-PHR	OP-05T308-HHR	-	IS-10-1	8T-9

A60: 28 - 29

Key on A60: 1

A60: 2 - 4

Mounting screws sold in multiples of 4 | Adjusting screws sold in multiples of 4
 IC inserts sold in multiples of 10 | Insert screws sold in multiples of 10

= Metric (mm)
 = Imperial (in)

56

 DRILLING | Revolution Drill® Large Diameter Replaceable IC Insert Drilling System

Revolution Drill Holders

56 Series | Diameter Range: 91.44 mm - 96.52 mm (3.600" - 3.800")



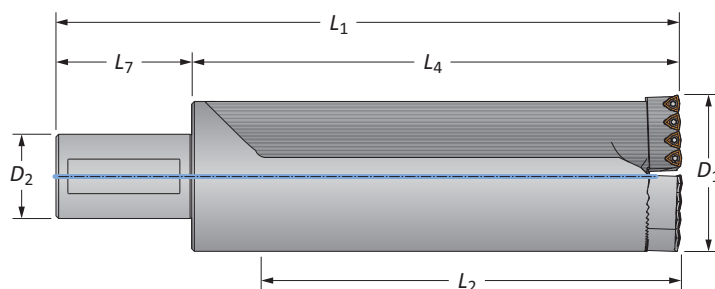

Straight Shank Metric

Style	Length	D ₁ Range	Holder			Shank			Part No.*	Cartridges
			L ₂	L ₄	L ₁	D ₂	L ₇	P ₁		
Standard	1.0xD	91.44 - 96.52	98.60	146.23	226.23	50.00	80.00	–	R56X10-50M	C56-...
Standard	2.5xD	91.44 - 96.52	238.30	285.93	365.93	50.00	80.00	–	R56X25-50M	C56-...
Stacked Plate	1.0xD	91.44 - 96.52	99.90	147.60	227.61	50.00	80.00	–	SP56X10-50M	C56SP-...
Stacked Plate	2.5xD	91.44 - 96.52	239.60	287.30	367.31	50.00	80.00	–	SP56X25-50M	C56SP-...

*Holder includes cartridges; however, inserts are sold separately.



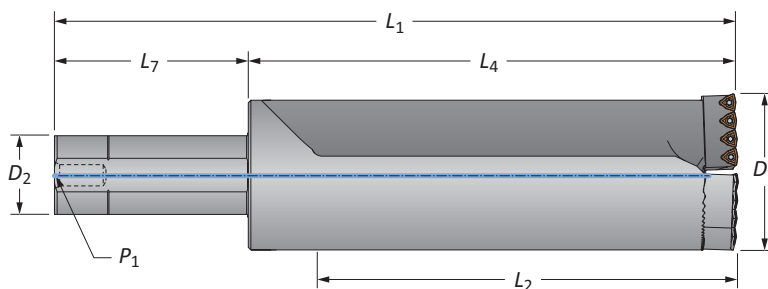

Straight Shank Imperial

Style	Length	D ₁ Range	Holder			Shank			Part No.*	Cartridges
			L ₂	L ₄	L ₁	D ₂	L ₇	P ₁		
Standard	1.0xD	3.600 - 3.800	3-7/8	5-3/4	10-1/4	2	4-1/2	1/4	R56X10-200L	C56-...
Standard	2.5xD	3.600 - 3.800	9-3/8	11-1/4	15-3/4	2	4-1/2	1/4	R56X25-200L	C56-...
Stacked Plate	1.0xD	3.600 - 3.800	3-15/16	5-13/16	10-5/16	2	4-1/2	1/4	SP56X10-200L	C56SP-...
Stacked Plate	2.5xD	3.600 - 3.800	9-7/16	11-5/16	15-13/16	2	4-1/2	1/4	SP56X25-200L	C56SP-...

*Holder includes cartridges; however, inserts are sold separately.

A DRILLING

B BORING

C REAMING

D BURNISHING

E THREADING

X SPECIALS

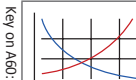
 A60: 28 - 29

 A60: 2 - 4

 M = Metric (mm)
 I = Imperial (in)

A60: 24

www.alliedmachine.com | +44 (0) 1384 400 900 | enquiries.eu@alliedmachine.com

Revolution Drill Holders

56 Series | Diameter Range: 91.44 mm - 96.52 mm (3.600" - 3.800")

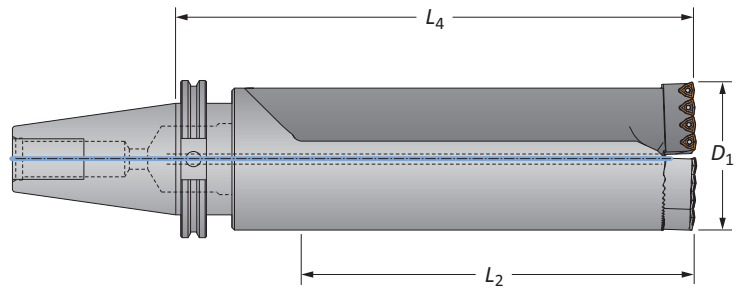

CV50 Shank

Style	Length	D ₁ Range	Holder		Shank	Part No.*	Cartridges	
			L ₂	L ₄				
i	Standard	1.0xD	3.600 - 3.800	3-7/8	7-1/8	CV50	R56X10-CV50	C56-...
	Standard	2.5xD	3.600 - 3.800	9-3/8	12-5/8	CV50	R56X25-CV50	C56-...
	Stacked Plate	1.0xD	3.600 - 3.800	3-15/16	7-3/16	CV50	SP56X10-CV50	C56SP-...
	Stacked Plate	2.5xD	3.600 - 3.800	9-7/16	12-11/16	CV50	SP56X25-CV50	C56SP-...

*Holder includes cartridges; however, inserts are sold separately.

Cartridges

Holder Part No.	Replacement Cartridges	Qty. Inserts Needed	Mounting Screw	Key Size	Adjusting Screw	Driver
R56...	C56-FIX	4	MS-21M-1	8 mm	AS-18T9-1	8T-9
	C56-ADJ	4	MS-21M-1	8 mm	AS-18T9-1	8T-9
SP56...	C56SP-FIX	4	MS-21M-1	8 mm	AS-18T9-1	8T-9
	C56SP-ADJ	4	MS-21M-1	8 mm	AS-18T9-1	8T-9

IC Inserts

Carbide Grade	Geometry	Part No.			Insert Screws	Driver
		AM300®	AM200®	TiN		
P35 (C5)	Standard	OP-05T308-P	OP-05T308-H	OP-05T308-T	IS-10-1	8T-9
K35 (C1)	Standard	OP-05T308-1P	OP-05T308-1H	OP-05T308-1T	IS-10-1	8T-9
K25 (C2)	Standard	OP-05T308-2P	OP-05T308-2H	-	IS-10-1	8T-9
P35 (C5)	High Rake	OP-05T308-PHR	OP-05T308-HHR	-	IS-10-1	8T-9

A60: 28 - 29

A60: 2 - 4

Mounting screws sold in multiples of 4 | Adjusting screws sold in multiples of 4
 IC inserts sold in multiples of 10 | Insert screws sold in multiples of 10

= Metric (mm)
 = Imperial (in)

58

 DRILLING | Revolution Drill® Large Diameter Replaceable IC Insert Drilling System

Revolution Drill Holders

58 Series | Diameter Range: 96.52 mm - 101.60 mm (3.800" - 4.000")

 A
DRILLING



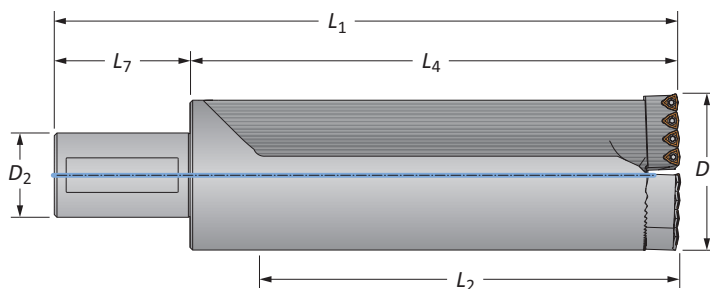

B

BORING

Straight Shank Metric

m	Style	Length	D ₁ Range	Holder			Shank			Part No.*	Cartridges
				L ₂	L ₄	L ₁	D ₂	L ₇	P ₁		
	Standard	1.0xD	96.52 - 101.60	98.60	146.20	226.20	50.00	80.00	–	R58X10-50M	C58-...
	Standard	2.5xD	96.52 - 101.60	251.00	298.60	378.60	50.00	80.00	–	R58X25-50M	C58-...
	Stacked Plate	1.0xD	96.52 - 101.60	99.80	147.40	227.41	50.00	80.00	–	SP58X10-50M	C58SP-...
	Stacked Plate	2.5xD	96.52 - 101.60	252.20	299.80	379.81	50.00	80.00	–	SP58X25-50M	C58SP-...

*Holder includes cartridges; however, inserts are sold separately.

 C
REAMING



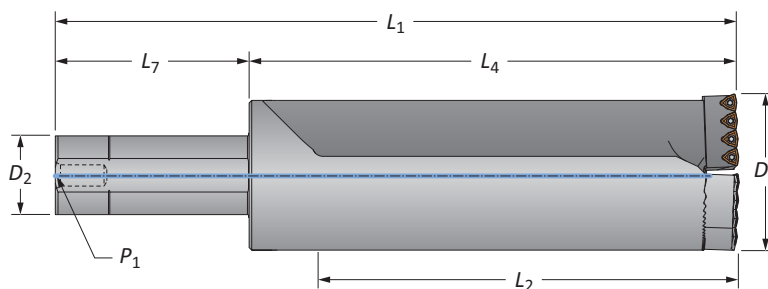

D

BURNISHING

Straight Shank Imperial

i	Style	Length	D ₁ Range	Holder			Shank			Part No.*	Cartridges
				L ₂	L ₄	L ₁	D ₂	L ₇	P ₁		
	Standard	1.0xD	3.800 - 4.000	3-7/8	5-3/4	10-1/4	2	4-1/2	1/4	R58X10-200L	C58-...
	Standard	2.5xD	3.800 - 4.000	9-7/8	11-3/4	16-1/4	2	4-1/2	1/4	R58X25-200L	C58-...
	Stacked Plate	1.0xD	3.800 - 4.000	3-15/16	5-13/16	10-5/16	2	4-1/2	1/4	SP58X10-200L	C58SP-...
	Stacked Plate	2.5xD	3.800 - 4.000	9-15/16	11-13/16	16-5/16	2	4-1/2	1/4	SP58X25-200L	C58SP-...

*Holder includes cartridges; however, inserts are sold separately.

 F
THREADING

 X
SPECIALS

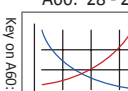
 A60: 28 - 29

 A60: 2 - 4

 m = Metric (mm)
 i = Imperial (in)

A60: 26

www.alliedmachine.com | +44 (0) 1384 400 900 | enquiries.eu@alliedmachine.com

Revolution Drill Holders

58 Series | Diameter Range: 96.52 mm - 101.60 mm (3.800" - 4.000")

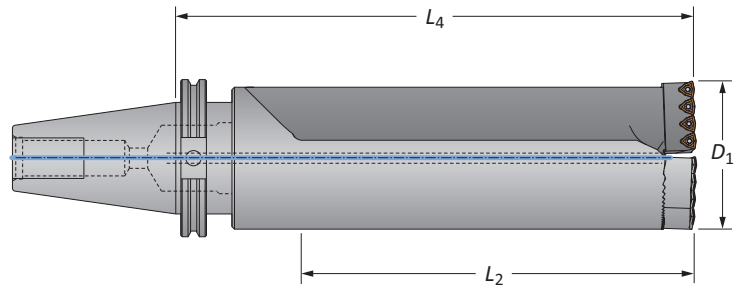

CV50 Shank

Style	Length	D ₁ Range	Holder		Shank	Part No.*	Cartridges	
			L ₂	L ₄				
i	Standard	1.0xD	3.800 - 4.000	3-7/8	7-1/8	CV50	R58X10-CV50	C58-...
	Standard	2.5xD	3.800 - 4.000	9-7/8	13-1/8	CV50	R58X25-CV50	C58-...
	Stacked Plate	1.0xD	3.800 - 4.000	3-15/16	7-3/16	CV50	SP58X10-CV50	C58SP-...
	Stacked Plate	2.5xD	3.800 - 4.000	9-15/16	13-3/16	CV50	SP58X25-CV50	C58SP-...

*Holder includes cartridges; however, inserts are sold separately.

Cartridges

Holder Part No.	Replacement Cartridges	Qty. Inserts Needed	Mounting Screw	Key Size	Adjusting Screw	Driver
R58...	C58-FIX	4	MS-21M-1	8 mm	AS-18T9-1	8T-9
	C58-ADJ	4	MS-21M-1	8 mm	AS-18T9-1	8T-9
SP58...	C58SP-FIX	4	MS-21M-1	8 mm	AS-18T9-1	8T-9
	C58SP-ADJ	4	MS-21M-1	8 mm	AS-18T9-1	8T-9

IC Inserts

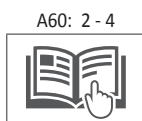
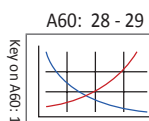

Carbide Grade	Geometry	Part No.			Insert Screws	Driver
		AM300®	AM200®	TiN		
P35 (C5)	Standard	OP-05T308-P	OP-05T308-H	OP-05T308-T	IS-10-1	8T-9
K35 (C1)	Standard	OP-05T308-1P	OP-05T308-1H	OP-05T308-1T	IS-10-1	8T-9
K25 (C2)	Standard	OP-05T308-2P	OP-05T308-2H	-	IS-10-1	8T-9
P35 (C5)	High Rake	OP-05T308-PHR	OP-05T308-HHR	-	IS-10-1	8T-9



Mounting screws sold in multiples of 4 | Adjusting screws sold in multiples of 4
 IC inserts sold in multiples of 10 | Insert screws sold in multiples of 10

m = Metric (mm)
 i = Imperial (in)

Recommended Cutting Data | Metric (mm)

ISO	Material	Hardness (BHN)	Speed (M/min)			Feed Rate (mm/rev)
			 AM300®	 AM200®	 TIN	
P	Free-Machining Steel 1118, 1215, 12L14, etc.	100 - 250	274 - 396	259 - 366	213 - 274	0.09 - 0.18
	Low-Carbon Steel 1010, 1020, 1025, 1522, 1144, etc.	85 - 275	259 - 381	244 - 351	198 - 259	0.08 - 0.17
	Medium-Carbon Steel 1030, 1040, 1050, 1527, 1140, 1151, etc.	125 - 325	244 - 320	229 - 290	183 - 259	0.09 - 0.17
	Alloy Steel 4140, 5140, 8640, etc.	125 - 375	229 - 305	213 - 274	183 - 259	0.09 - 0.17
	High-Strength Alloy 4340, 4330V, 300M, etc.	225 - 400	183 - 259	168 - 229	122 - 198	0.08 - 0.13
	Structural Steel A36, A285, A516, etc.	100 - 350	259 - 320	244 - 290	198 - 259	0.08 - 0.17
	Tool Steel H-13, H-21, A-4, O-2, S-3, etc.	150 - 250	122 - 244	107 - 213	76 - 198	0.06 - 0.13
S	High-Temp Alloy Hastelloy B, Inconel 600, etc.	140 - 310	76 - 137	76 - 107	46 - 91	0.06 - 0.11
M	Stainless Steel 400 Series 416, 420, etc.	185 - 350	183 - 259	168 - 229	122 - 198	0.08 - 0.15
	Stainless Steel 300 Series 304, 316, 17-4PH, etc.	135 - 275	183 - 259	168 - 229	122 - 198	0.08 - 0.15
	Super Duplex Stainless Steel	135 - 275	152 - 228	137 - 198	91 - 152	0.05 - 0.12
K	Nodular, Grey, Ductile Cast Iron	120 - 320	213 - 274	198 - 244	152 - 213	0.10 - 0.20
N	Cast Aluminium	30 - 180	381 - 503	381 - 472	290 - 335	0.15 - 0.30
	Wrought Aluminium	30 - 180	381 - 503	381 - 472	290 - 335	0.15 - 0.30
	Brass	30 - 100	290 - 411	274 - 381	229 - 335	0.13 - 0.23

Material Constants

Type of Material	Hardness (BHN)	K _m (kPa)
Free-Machining Steel	100 - 250	5.17
Low-Carbon Steel	85 - 275	5.86
Medium-Carbon Steel	125 - 325	6.21
Alloy Steel	125 - 375	6.90
High-Strength Steel	225 - 400	7.93
Structural Steel	100 - 350	6.90
Tool Steel	150 - 250	6.21
High-Temperature Alloy	140 - 310	9.93
Titanium Alloy	140 - 310	4.97
Aerospace Alloy	185 - 350	4.48
Stainless Steel 400 Series	185 - 350	7.45
Stainless Steel 300 Series	135 - 275	6.48
Super Duplex Stainless Steel	135 - 275	6.48
Wear Plate	400 - 600	11.04
Hardened Steel	300 - 500	9.66
Nodular, Ductile Cast Iron	120 - 320	4.48
Grey Cast Iron	120 - 320	5.17
Cast Aluminium	30 - 180	2.76
Wrought Aluminium	30 - 180	2.76
Aluminium Bronze	100 - 250	3.45
Brass	100	2.41
Copper	60	2.07



Formulas

1. RPM	= (318.31 • M/min) / DIA
where:	
RPM	= revolutions per minute (rev/min)
M/min	= speed (M/min)
DIA	= diameter of drill (mm)
2. kW	= (DIA² • mm/rev • RPM • K_m) / 181,018
where:	
kW	= tool power (kW)
DIA	= diameter of drill (mm)
mm/rev	= feed rate (mm/rev)
RPM	= revolutions per minute (rev/min)
K _m	= specific cutting energy (kPa) machine efficiency (using 181,018 as constant)
3. Thrust	= 148.78 • mm/rev • DIA • K_m
where:	
Thrust	= axial thrust (N)
mm/rev	= feed rate (mm/rev)
DIA	= diameter of drill (mm)
K _m	= specific cutting energy (kPa)
5. Torque	= (kW • 9549.3) / RPM
where:	
Torque	= torque (Nm)
HP	= tool power (kW)
RPM	= revolutions per minute (rev/min)

The table and equations on this page are found in the *Machinery's Handbook*. Permission to simplify and print the equations is granted by the Editor of the *Machinery's Handbook*.

IMPORTANT: The speeds and feeds listed above are considered a general starting point for all applications. Factory technical assistance is available for your specific applications through our Application Engineering department. email: engineering.eu@alliedmachine.com

Recommended Cutting Data | Imperial (inch)

ISO	Material	Hardness (BHN)	Speed (SFM)			Feed Rate (IPR)
			 AM300®	 AM200®	 TIN	
P	Free-Machining Steel 1118, 1215, 12L14, etc.	100 - 250	900 - 1300	850 - 1200	700 - 900	0.0035 - 0.007
	Low-Carbon Steel 1010, 1020, 1025, 1522, 1144, etc.	85 - 275	850 - 1250	800 - 1150	650 - 850	0.003 - 0.0065
	Medium-Carbon Steel 1030, 1040, 1050, 1527, 1140, 1151, etc.	125 - 325	800 - 1050	750 - 950	600 - 850	0.0035 - 0.0065
	Alloy Steel 4140, 5140, 8640, etc.	125 - 375	750 - 1000	700 - 900	600 - 850	0.0035 - 0.0065
	High-Strength Alloy 4340, 4330V, 300M, etc.	225 - 400	600 - 850	550 - 750	400 - 650	0.003 - 0.005
	Structural Steel A36, A285, A516, etc.	100 - 350	850 - 1050	800 - 950	650 - 850	0.003 - 0.0065
	Tool Steel H-13, H-21, A-4, O-2, S-3, etc.	150 - 250	400 - 800	350 - 700	250 - 650	0.0025 - 0.005
S	High-Temp Alloy Hastelloy B, Inconel 600, etc.	140 - 310	250 - 450	250 - 350	150 - 300	0.0025 - 0.005
M	Stainless Steel 400 Series 416, 420, etc.	185 - 350	600 - 850	550 - 750	400 - 650	0.003 - 0.006
	Stainless Steel 300 Series 304, 316, 17-4PH, etc.	135 - 275	600 - 850	550 - 750	400 - 650	0.003 - 0.006
	Super Duplex Stainless Steel	135 - 275	500 - 750	450 - 650	300 - 550	0.002 - 0.005
K	Nodular, Grey, Ductile Cast Iron	120 - 320	700 - 900	650 - 800	500 - 700	0.004 - 0.008
N	Cast Aluminium	30 - 180	1250 - 1650	1200 - 1550	950 - 1100	0.006 - 0.012
	Wrought Aluminium	30 - 180	1250 - 1650	1200 - 1550	950 - 1100	0.006 - 0.012
	Brass	30 - 100	950 - 1350	900 - 1250	750 - 1100	0.005 - 0.009

Material Constants

Type of Material	Hardness (BHN)	K _m (lbs/in ²)
Free-Machining Steel	100 - 250	0.75
Low-Carbon Steel	85 - 275	0.85
Medium-Carbon Steel	125 - 325	0.90
Alloy Steel	125 - 375	1.00
High-Strength Steel	225 - 400	1.15
Structural Steel	100 - 350	1.00
Tool Steel	150 - 250	0.90
High-Temperature Alloy	140 - 310	1.44
Titanium Alloy	140 - 310	0.72
Aerospace Alloy	185 - 350	0.70
Stainless Steel 400 Series	185 - 350	1.08
Stainless Steel 300 Series	135 - 275	0.94
Super Duplex Stainless Steel	135 - 275	0.94
Wear Plate	400 - 600	1.60
Hardened Steel	300 - 500	1.40
Nodular, Ductile Cast Iron	120 - 320	0.65
Grey Cast Iron	120 - 320	0.75
Cast Aluminium	30 - 180	0.40
Wrought Aluminium	30 - 180	0.40
Aluminium Bronze	100 - 250	0.50
Brass	100	0.35
Copper	60	0.30

Formulas

1. RPM	= (3.82 • SFM) / DIA
where:	
RPM	= revolutions per minute (rev/min)
SFM	= speed (ft/min)
DIA	= diameter of drill (inch)
2. HP	= (0.6676 • DIA² • IPR • RPM • K_m) / 0.80
where:	
Tool Power	= tool power (HP)
DIA	= diameter of drill (inch)
IPR	= feed rate (in/rev)
RPM	= revolutions per minute (rev/min)
K _m	= specific cutting energy (lbs/in ²) machine efficiency (using 0.80 as constant)
3. Thrust	= 148,500 • IPR • DIA • K_m
where:	
Thrust	= axial thrust (lbs)
IPR	= feed rate (in/rev)
DIA	= diameter of drill (inch)
K _m	= specific cutting energy (lbs/in ²)
5. Torque	= (HP • 5252) / RPM
where:	
Torque	= torque (ft/lbs)
HP	= tool power (HP)
RPM	= revolutions per minute (rev/min)

The table and equations on this page are found in the *Machinery's Handbook*. Permission to simplify and print the equations is granted by the Editor of the *Machinery's Handbook*.

IMPORTANT: The speeds and feeds listed above are considered a general starting point for all applications. Factory technical assistance is available for your specific applications through our Application Engineering department. email: engineering.eu@alliedmachine.com

Warranty Information



Allied Machine & Engineering ("Allied Machine") warrants to original equipment manufacturers, distributors, industrial and commercial users of its products for one year from the original date of sale that each new product manufactured or supplied by Allied Machine shall be free from defects in material and workmanship.

Allied Machine's sole and exclusive obligation under this warranty is limited to, at its option, without additional charge, replacing or repairing this product or issuing a credit. For this warranty to be applied, the product must be returned freight prepaid to the plant designated by an Allied Machine representative and which, upon inspection, is determined by Allied Machine to be defective in material and workmanship.

Complete information as to operating conditions, machine, setup, and the application of cutting fluid should accompany any product returned for inspection. This warranty shall not apply to any Allied Machine products which have been subjected to misuse, abuse, improper operating conditions, improper machine setup or improper application of cutting fluid or which have been repaired or altered if such repair or alteration, in the judgement of Allied Machine, would adversely affect the performance of the product.

THIS WARRANTY IS IN LIEU OF ALL OTHER WARRANTIES, EXPRESS OR IMPLIED, INCLUDING ANY IMPLIED WARRANTY OF MERCHANTABILITY OR FITNESS FOR A PARTICULAR PURPOSE. Allied Machine shall have no liability or responsibility for any claim, whether in contract, tort or otherwise, for any loss or damage arising out of, connected with, or resulting from the manufacture, sale, delivery or use of any product sold hereunder, in excess of the cost of replacement or repair as provided herein.

Allied Machine shall not be liable in contract or in tort (including, without limitation, negligence, strict liability or otherwise) for economic losses of any kind or for any special, incidental, indirect, consequential, punitive or exemplary damages arising in any way out of the performance of, or failure to perform this agreement.

ALL PRICES, DELIVERIES, DESIGNS, AND MATERIALS ARE SUBJECT TO CHANGE WITHOUT NOTICE.



Allied Machine & Engineering Co. Europe Ltd. is registered to ISO 9001:2015 by bsi.



Allied Machine & Engineering is registered to ISO 9001:2015 by DQS



Wohlhaupter GmbH is registered to ISO 9001:2015 by QA TECHNIC

Europe

Allied Machine & Engineering Co. (Europe) Ltd.

93 Vantage Point
Pensnett Estate
Kingswinford
West Midlands
DY6 7FR England

Phone:

+44 (0) 1384.400900

Wohlhaupter GmbH

Maybachstrasse 4
Postfach 1264
72636 Frickenhausen
Germany

Phone:

+49 (0) 7022.408.0

Fax:

+49 (0) 7022.408.212

United States

Allied Machine & Engineering

120 Deeds Drive
Dover OH 44622
United States

Phone:

+1.330.343.4283

Fax:

+1.330.602.3400

Toll Free USA and Canada:

800.321.5537

Toll Free USA and Canada:

800.223.5140

Allied Machine & Engineering

485 W Third Street
Dover OH 44622
United States

Phone:

+1.330.343.4283

Fax:

+1.330.364.7666
(Engineering Dept.)

Toll Free USA and Canada:

800.321.5537

Asia

Wohlhaupter India Pvt. Ltd.

B-23, 3rd Floor
B Block Community Centre
Janakpuri, New Delhi - 110058
India

Phone:

+91 (0) 11.41827044

Your local Allied Machine representative:

www.alliedmachine.com

Allied Machine & Engineering Co. (Europe) Ltd is registered to **ISO 9001:2015** by bsi.

Allied Machine & Engineering is registered to **ISO 9001:2015** by DQS

Wohlhaupter GmbH is registered to **ISO 9001:2015** by QTA TECHNIC

