



**ALLIED MACHINE  
& ENGINEERING**

**WOHLHAUPTER®**

Holemaking Solutions for Today's Manufacturing



Boring



Reaming



Burnishing



Threading



Specials



## 4TEX® Drill

▶ *DRILLING*

Indexable Insert Drilling System



SECTION

---

# A55

---

4TEX® Drill

# 4TEX® Drill

## Indexable Carbide Insert Drilling System

► **Diameter Range:** 12.00 mm - 47.00 mm (0.472" - 1.850")



### Don't Let Your Machine Slow You Down

The 4TEX indexable carbide drill provides increased penetration rates on light duty machines due to the single effective design. With twisted coolant outlets and increased core strength, the design provides improved hole size and finish.

The four-sided 4TEX inserts are designed to use two sides in the center pocket and two sides in the periphery pocket for an improved cost per hole. With insert geometries available for all ISO material classes and a robust body design, the 4TEX is suited for your difficult applications.

Improved hole size and finish	Superior chip evacuation	Increased penetration rates
-------------------------------	--------------------------	-----------------------------

### Applicable Industries



Aerospace



Agriculture



Automotive



Firearms



General  
Machining



Oil & Gas



Renewable  
Energy

Your safety and the safety of others is very important. This catalogue contains important safety messages. Always read and follow all safety precautions.



This triangle is a safety hazard symbol. It alerts you to potential safety hazards that can cause tool failure and serious injury.

When you see this symbol in the catalogue, look for a related safety message that may be near this triangle or referred to in the nearby text.

There are safety signal words also used in the catalogue. Safety messages follow these words.

#### **WARNING**

**WARNING** (shown above) means that failure to follow the precautions in this message could result in tool failure and serious injury.

**NOTICE** means that failure to follow the precautions in this message could result in damage to the tool or machine but not result in personal injury.

**NOTE** and **IMPORTANT** are also used. These are important that you read and follow but are not safety-related.

Visit [www.alliedmachine.com](http://www.alliedmachine.com) for the most up-to-date information and procedures.

## Reference Icons

The following icons will appear throughout the catalogue to help you navigate between products.



### Setup / Assembly Information

Detailed instructions and information regarding the corresponding part(s)

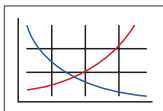

### Recommended Cutting Data

Speed and feed recommendations for optimum and safe drilling

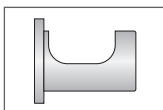

### Eccentric Sleeves

Refers to the corresponding eccentric sleeve for the holder



### Through Coolant Option

Indicates that the product is through coolant

Series	Diameter Range	
	Metric (mm)	Imperial (inch)
03	12.00 - 13.49	0.472 - 0.531
04	13.50 - 15.49	0.532 - 0.610
05	15.50 - 18.49	0.611 - 0.728
06	18.50 - 21.99	0.728 - 0.866
07	22.00 - 26.49	0.867 - 1.043
09	26.50 - 31.99	1.044 - 1.259
11	32.00 - 38.99	1.260 - 1.535
14	39.00 - 47.00	1.536 - 1.850

## Introduction Information

Product Overview . . . . .	2
Insert Information . . . . .	3 - 4
Product Nomenclature . . . . .	5

## Drill Series

03 Series . . . . .	6 - 7
04 Series . . . . .	8 - 9
05 Series . . . . .	10 - 11
06 Series . . . . .	12 - 13
07 Series . . . . .	14 - 15
09 Series . . . . .	16 - 19
11 Series . . . . .	20 - 23
14 Series . . . . .	24 - 27

Eccentric Sleeves . . . . .	28
-----------------------------	----

## Technical Information

Diameter Adjustment . . . . .	29
Center Height Alignment . . . . .	30 - 31

## Recommended Cutting Data

Metric (mm) . . . . .	32
Imperial (inch) . . . . .	33

Insert Geometry Recommendations . . . . .	34
---	----

Troubleshooting Guide . . . . .	35
---------------------------------	----

Safety Information . . . . .	36
------------------------------	----

Product Overview

A  
DRILLING  
B  
BORING  
C  
REAMING  
D  
BURNISHING  
E  
THREADING  
X  
SPECIALS

# 4TEX Drill *Advantages*

- ✓ **Superior chip evacuation**  
provided by the two twisted coolant holes
- ✓ **Improved hole size**  
from the increased holder rigidity
- ✓ **Longer tool life**  
provided by the four-sided insert design
- ✓ **Optimal chip formation**  
with ISO-specific insert geometry/coating combinations
- ✓ **Competitive cycle times**  
due to single effective cutting when using light duty machines

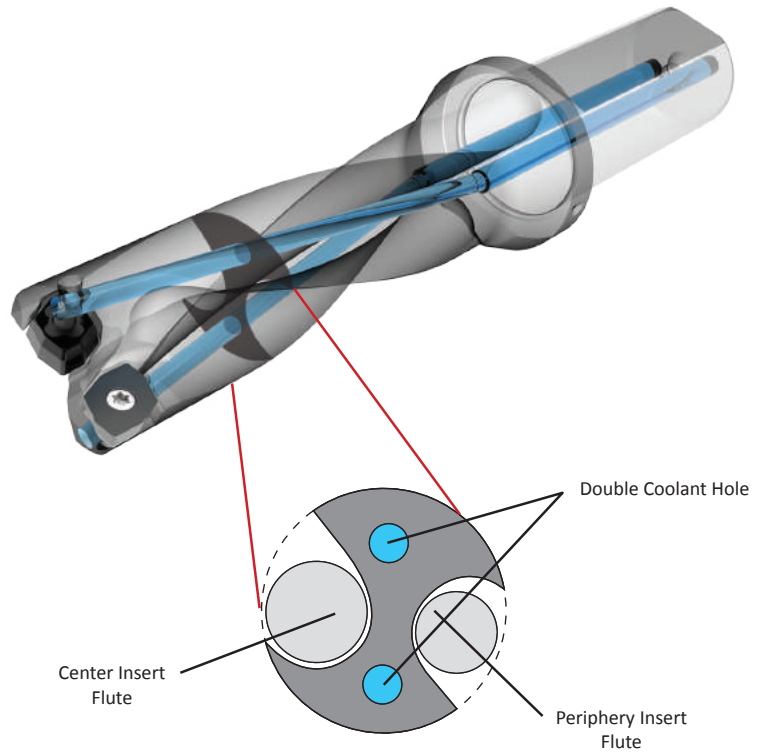

## DESIGNED TO GIVE YOU *IMPROVED* HOLE SIZE AND STRAIGHTNESS

- The two twisted coolant holes allow the core to remain intact, making the core thicker and stronger for improved hole straightness even in uneven surfaces.
- The enlarged dual coolant outlets increase the coolant volume, which improved the chip evacuation resulting in improved hole size.
- The flute space of the internal cutting edge side (where chips get stuck most often) is 1.6x larger than typical IC drills, helping to mitigate catastrophic failures and improve hole size.

### *LONGER* TOOL LIFE

### AVAILABLE *LENGTHS*

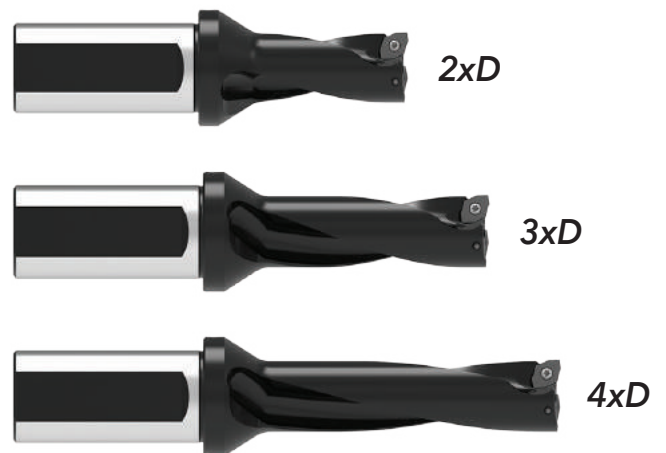

Insert Information

# 4 CUTTING EDGES

- Each insert has two inner cutting edges and two outer cutting edges
- Economical solution that increases tool life because of the rotation ability of the inserts
- Available in ISO material-specific geometry/coating combinations

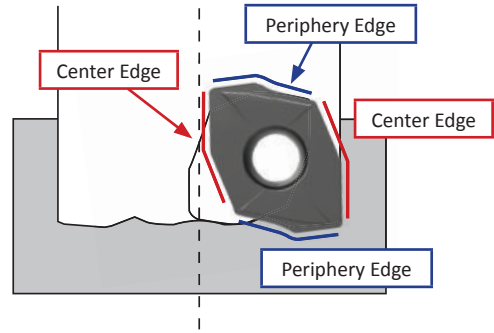

Periphery Insert



Periphery edge chip formation:



Center Insert





Center edge chip formation:



ISO Material	Geometry	Coating	Description
<b>P</b>	General Rake	AM480	A general purpose geometry that provides excellent chip formation in most steels including free-machining, medium- and high-carbon steels. A P30 carbide substrate for improved toughness and AM480 coating, a proprietary wear resistant multilayer PVD coating to improve tool life.
<b>S</b> <b>M</b>	High Rake	AM485	A higher rake geometry that provides excellent chip formation in both stainless steels and high-temperature alloys. A tough M25 carbide substrate coated with AM485, a high heat resistance proprietary multilayer PVD coating.
<b>H</b>	Low Rake	AM480	A lower rake geometry to improve edge strength in both hardened tool steels and high-strength alloys. With a P30 carbide substrate for improved toughness and coated with AM480, a proprietary multilayer PVD coating to improve resistance against tool wear.
<b>K</b>	General Rake	AM480	With a general purpose geometry, the K inserts can be used in grey cast irons as well as ductile irons. A high wear-resistant K10 carbide substrate to improve tool life and coated with AM480, a proprietary multilayer PVD coating to improve resistance against tool wear.
<b>N</b>	High Rake	TiCN	A higher rake cutting geometry provides excellent chip formation in non-ferrous materials. An M15/K15 carbide substrate paired with TiCN coating for improved lubricity to resist built-up material, increasing tool life and maintaining chip formation.

Insert Information

Series	Insert Prefix	Dimension (mm)					Angle		Shape
		$L_1$	$L_2$	$T$	$D_1$	$R$	$A_1$	$A_2$	
03	4T-030203C-x	5.60	4.80	2.30	2.40	0.30	7°	10°	 Style 1
	4T-030203P-x	6.38	4.77	2.30	2.40	0.30	7°	10°	 Style 2
04	4T-040203-x	6.21	5.06	2.60	2.45	0.30	13°	10°	 Style 3
05	4T-05T203-x	7.26	5.48	2.76	2.55	0.30	13°	7°	
06	4T-06T204-x	8.59	6.44	2.89	2.79	0.40	13°	7°	
07	4T-070305-x	10.21	8.02	3.24	3.00	0.50	13°	7°	
09	4T-09T306-x	12.18	9.55	4.03	3.64	0.60	13°	7°	
11	4T-11T306-x	14.50	11.61	4.06	4.62	0.60	13°	7°	
14	4T-140408-x	17.99	14.40	4.88	5.76	0.80	13°	7°	

Style 1

Style 2

Style 3

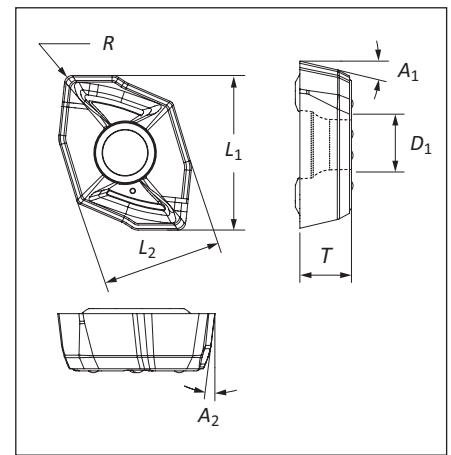
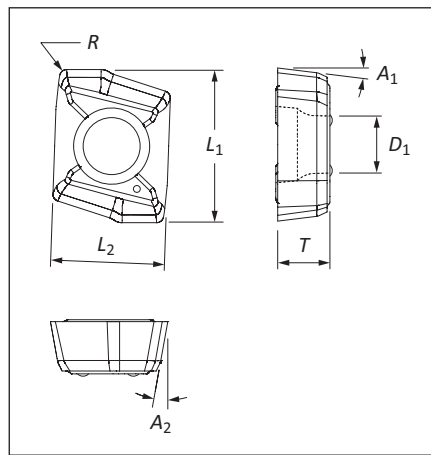
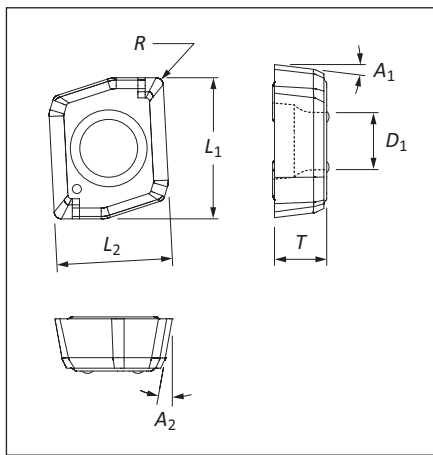



## Product Nomenclature

### 4TEX Drill Holders

<b>D4</b>	<b>03</b>	<b>1200</b>	<b>M</b>	-	<b>20</b>	<b>FM</b>
1	2	3*	4		5	6

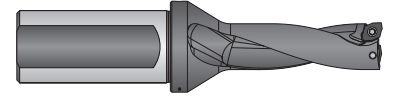

1. Length to Diameter Ratio
<b>D2</b> = 2xD
<b>D3</b> = 3xD
<b>D4</b> = 4xD

2. Series	
<b>03</b> = 03 series	<b>07</b> = 07 series
<b>04</b> = 04 series	<b>09</b> = 09 series
<b>05</b> = 05 series	<b>11</b> = 11 series
<b>06</b> = 06 series	<b>14</b> = 14 series

3. Diameter*
<b>1200</b> = 12 mm
<b>0750</b> = 0.075"

4. Diameter Style
<b>M</b> = Metric
<b>I</b> = Imperial

5. Shank Diameter	
Metric	Imperial
<b>20</b> = 20 mm	<b>075</b> = 0.75"
<b>25</b> = 25 mm	<b>100</b> = 1.000"
<b>32</b> = 32 mm	<b>125</b> = 1.250"
<b>40</b> = 40 mm	<b>150</b> = 1.500"

6. Shank Style
<b>FM</b> = Metric flanged shank
<b>F</b> = Imperial flanged shank

**\*Ordering Non-Stocked Diameters:**

Non-stocked diameters are available upon request. Please refer to price list for applicable process fees.

**Ordering example:**

Metric: 03 Series (12.65 mm) = D2031265M-20FM  
 Inch: 03 Series (Ø .480") = D2030480I-075F

**Reference Key**

Symbol	Attribute
$D_1$	Drill diameter
$D_2$	Shank diameter
$D_3$	Flange diameter
$L_1$	Assembled overall length
$L_2$	Drill depth
$L_3$	Reference length

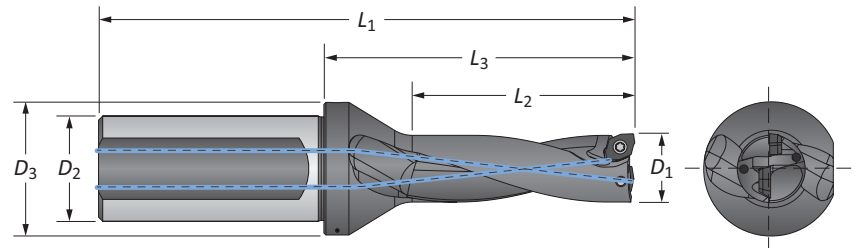

A  
DRILLING  
B  
BORING  
C  
REAMING  
D  
BURNISHING  
E  
THREADING  
X  
SPECIALS

## 4TEX Drill Holders | Metric Shank

03 Series | Diameter Range: 12.00 mm - 13.49 mm (0.472" - 0.531")

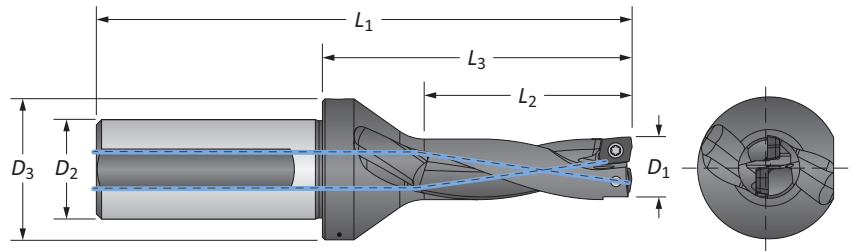

### Metric Shank

Length	D <sub>1</sub>		Body			Shank		Max Offset	Part No.
	mm	in	L <sub>2</sub>	L <sub>3</sub>	L <sub>1</sub>	D <sub>2</sub>	D <sub>3</sub>		
2xD	12.00	0.472	24.00	45.40	88.40	20.00	27.00	0.50	D2031200M-20FM
	12.50	0.492	25.00	46.40	89.40	20.00	27.00	0.40	D2031250M-20FM
	12.70	0.500	25.40	46.40	89.40	20.00	27.00	0.35	D2030500I-20FM
	13.00	0.512	26.00	47.40	90.40	20.00	27.00	0.30	D2031300M-20FM
3xD	12.00	0.472	36.00	57.40	100.40	20.00	27.00	0.50	D3031200M-20FM
	12.50	0.492	37.50	58.90	101.90	20.00	27.00	0.40	D3031250M-20FM
	12.70	0.500	38.10	58.90	101.90	20.00	27.00	0.35	D3030500I-20FM
	13.00	0.512	39.00	60.40	103.40	20.00	27.00	0.30	D3031300M-20FM
4xD	12.00	0.472	48.00	69.40	112.40	20.00	27.00	0.50	D4031200M-20FM
	12.50	0.492	50.00	71.40	114.40	20.00	27.00	0.40	D4031250M-20FM
	12.70	0.500	50.80	71.40	114.40	20.00	27.00	0.35	D4030500I-20FM
	13.00	0.512	52.00	73.40	116.40	20.00	27.00	0.30	D4031300M-20FM

### IC Inserts

ISO Material	Style	Part No.	Insert Screw	Torx® Driver	Admissible Tightening Torque
P	Center	4T-030203C-P	7241-T6-1	8T-6	0.5 N-m (4.4 in-lbs)
	Periphery	4T-030203P-P			
S M	Center	4T-030203C-M			
	Periphery	4T-030203P-M			
H	Center	4T-030203C-H			
	Periphery	4T-030203P-H			
K	Center	4T-030203C-K			
	Periphery	4T-030203P-K			
N	Center	4T-030203C-N			
	Periphery	4T-030203P-N			

### Expected Hole Tolerances

Length	mm	in
2xD	-0.10 / +0.20	-0.004 / +0.008
3xD	-0.10 / +0.20	-0.004 / +0.008
4xD	-0.10 / +0.25	-0.004 / +0.010

A55: 32 - 33

A55: 29 - 31

A55: 28

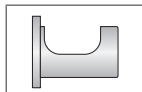
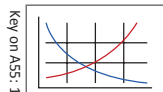

Key on A55: 1

Ⓜ = Metric (mm)  
Ⓢ = Imperial (in)

IC inserts sold in quantities of 10  
Insert screws sold in quantities of 10

### 4TEX Drill Holders | Imperial Shank

03 Series | Diameter Range: 12.00 mm - 13.49 mm (0.472" - 0.531")

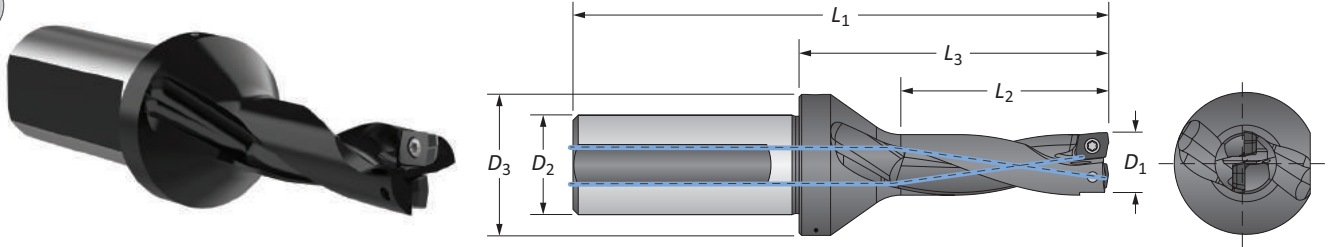

#### Imperial Shank

Length	D <sub>1</sub>		Body			Shank		Max Offset	Part No.
	mm	in	L <sub>2</sub>	L <sub>3</sub>	L <sub>1</sub>	D <sub>2</sub>	D <sub>3</sub>		
2xD	12.00	0.472	0.945	1.787	3.480	0.750	1.063	0.020	D2031200M-075F
	12.50	0.492	0.984	1.827	3.520	0.750	1.063	0.016	D2031250M-075F
	12.70	0.500	1.000	1.827	3.520	0.750	1.063	0.014	D2030500I-075F
	13.00	0.512	1.024	1.866	3.559	0.750	1.063	0.012	D2031300M-075F
3xD	12.00	0.472	1.417	2.260	3.953	0.750	1.063	0.020	D3031200M-075F
	12.50	0.492	1.476	2.319	4.012	0.750	1.063	0.016	D3031250M-075F
	12.70	0.500	1.500	2.319	4.012	0.750	1.063	0.014	D3030500I-075F
	13.00	0.512	1.535	2.378	4.071	0.750	1.063	0.012	D3031300M-075F
4xD	12.00	0.472	1.890	2.732	4.425	0.750	1.063	0.020	D4031200M-075F
	12.50	0.492	1.969	2.811	4.504	0.750	1.063	0.016	D4031250M-075F
	12.70	0.500	2.000	2.811	4.504	0.750	1.063	0.014	D4030500I-075F
	13.00	0.512	2.047	2.890	4.583	0.750	1.063	0.012	D4031300M-075F

#### IC Inserts

ISO Material	Style	Part No.	Insert Screw	Torx® Driver	Admissible Tightening Torque
P	Center	4T-030203C-P	7241-T6-1	8T-6	0.5 N-m (4.4 in-lbs)
	Periphery	4T-030203P-P			
S M	Center	4T-030203C-M			
	Periphery	4T-030203P-M			
H	Center	4T-030203C-H			
	Periphery	4T-030203P-H			
K	Center	4T-030203C-K			
	Periphery	4T-030203P-K			
N	Center	4T-030203C-N			
	Periphery	4T-030203P-N			

#### Expected Hole Tolerances

Length	mm	in
2xD	-0.10 / +0.20	-0.004 / +0.008
3xD	-0.10 / +0.20	-0.004 / +0.008
4xD	-0.10 / +0.25	-0.004 / +0.010

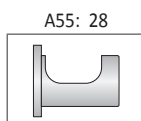
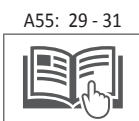
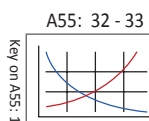

Ⓜ = Metric (mm)  
Ⓢ = Imperial (in)

IC inserts sold in quantities of 10  
Insert screws sold in quantities of 10

## 4TEX Drill Holders | Metric Shank

04 Series | Diameter Range: 13.50 mm - 15.49 mm (0.532" - 0.610")

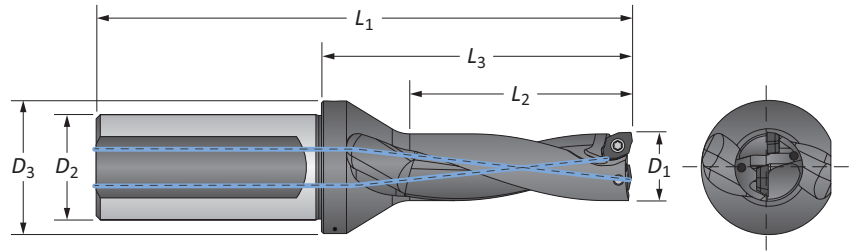

### Metric Shank

Length	D <sub>1</sub>		Body			Shank		Max Offset	Part No.
	mm	in	L <sub>2</sub>	L <sub>3</sub>	L <sub>1</sub>	D <sub>2</sub>	D <sub>3</sub>		
2xD	13.50	0.531	27.00	48.40	91.40	20.00	27.00	0.50	D2041350M-20FM
	14.00	0.551	28.00	49.40	92.40	20.00	27.00	0.40	D2041400M-20FM
	14.29	0.563	28.55	49.40	92.40	20.00	27.00	0.30	D2040562I-20FM
	14.50	0.571	29.00	50.40	93.40	20.00	27.00	0.30	D2041450M-20FM
	15.00	0.591	30.00	51.40	94.40	20.00	27.00	0.20	D2041500M-20FM
3xD	13.50	0.531	40.50	61.90	104.90	20.00	27.00	0.50	D3041350M-20FM
	14.00	0.551	42.00	63.40	106.40	20.00	27.00	0.40	D3041400M-20FM
	14.29	0.563	42.82	63.40	106.40	20.00	27.00	0.30	D3040562I-20FM
	14.50	0.571	43.50	64.90	107.90	20.00	27.00	0.30	D3041450M-20FM
	15.00	0.591	45.00	66.40	109.40	20.00	27.00	0.20	D3041500M-20FM
4xD	13.50	0.531	54.00	75.40	118.40	20.00	27.00	0.50	D4041350M-20FM
	14.00	0.551	56.00	77.40	120.40	20.00	27.00	0.40	D4041400M-20FM
	14.29	0.563	57.10	77.40	120.40	20.00	27.00	0.30	D4040562I-20FM
	14.50	0.571	58.00	79.40	122.40	20.00	27.00	0.30	D4041450M-20FM
	15.00	0.591	60.00	81.40	124.40	20.00	27.00	0.20	D4041500M-20FM

### IC Inserts

ISO Material	Part No.	Insert Screw	Torx® Driver	Admissible Tightening Torque
P	4T-040203-P	7241-T6-1	8T-6	0.5 N-m (4.4 in-lbs)
S	4T-040203-M			
H	4T-040203-H			
K	4T-040203-K			
N	4T-040203-N			

### Expected Hole Tolerances

Length	mm	in
2xD	-0.10 / +0.20	-0.004 / +0.008
3xD	-0.10 / +0.20	-0.004 / +0.008
4xD	-0.10 / +0.25	-0.004 / +0.010

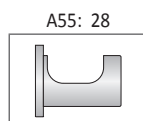
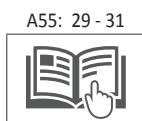
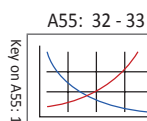

Key on A55: 1

m = Metric (mm)  
i = Imperial (in)

IC inserts sold in quantities of 10  
Insert screws sold in quantities of 10

## 4TEX Drill Holders | Imperial Shank

04 Series | Diameter Range: 13.50 mm - 15.49 mm (0.532" - 0.610")

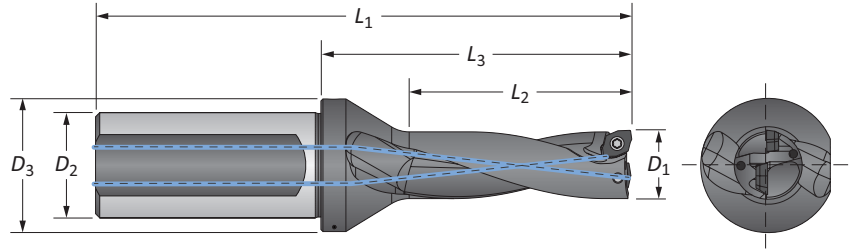

### Imperial Shank

Length	D <sub>1</sub>		Body			Shank		Max Offset	Part No.
	mm	in	L <sub>2</sub>	L <sub>3</sub>	L <sub>1</sub>	D <sub>2</sub>	D <sub>3</sub>		
2xD	13.50	0.531	1.063	1.906	3.598	0.750	1.063	0.020	D2041350M-075F
	14.00	0.551	1.102	1.945	3.638	0.750	1.063	0.016	D2041400M-075F
	14.29	0.563	1.124	1.945	3.638	0.750	1.063	0.013	D2040562I-075F
	14.50	0.571	1.142	1.984	3.677	0.750	1.063	0.012	D2041450M-075F
	15.00	0.591	1.181	2.024	3.717	0.750	1.063	0.008	D2041500M-075F
3xD	13.50	0.531	1.594	2.437	4.130	0.750	1.063	0.020	D3041350M-075F
	14.00	0.551	1.654	2.496	4.189	0.750	1.063	0.016	D3041400M-075F
	14.29	0.563	1.686	2.496	4.189	0.750	1.063	0.013	D3040562I-075F
	14.50	0.571	1.713	2.555	4.248	0.750	1.063	0.012	D3041450M-075F
	15.00	0.591	1.772	2.614	4.307	0.750	1.063	0.008	D3041500M-075F
4xD	13.50	0.531	2.126	2.969	4.661	0.750	1.063	0.020	D4041350M-075F
	14.00	0.551	2.205	3.047	4.740	0.750	1.063	0.016	D4041400M-075F
	14.29	0.563	2.248	3.047	4.740	0.750	1.063	0.013	D4040562I-075F
	14.50	0.571	2.283	3.126	4.819	0.750	1.063	0.012	D4041450M-075F
	15.00	0.591	2.362	3.205	4.898	0.750	1.063	0.008	D4041500M-075F

### IC Inserts

ISO Material	Part No.	Insert Screw	Torx® Driver	Admissible Tightening Torque
P	4T-040203-P	7241-T6-1	8T-6	0.5 N-m (4.4 in-lbs)
S	4T-040203-M			
H	4T-040203-H			
K	4T-040203-K			
N	4T-040203-N			

### Expected Hole Tolerances

Length	mm	in
2xD	-0.10 / +0.20	-0.004 / +0.008
3xD	-0.10 / +0.20	-0.004 / +0.008
4xD	-0.10 / +0.25	-0.004 / +0.010

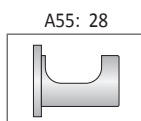
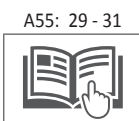
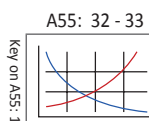

m = Metric (mm)  
i = Imperial (in)

IC inserts sold in quantities of 10  
Insert screws sold in quantities of 10

05

 DRILLING | 4TEX® Drill: Indexable Carbide Insert Drilling System

## 4TEX Drill Holders | Metric Shank

05 Series | Diameter Range: 15.50 mm - 18.49 mm (0.611" - 0.728")

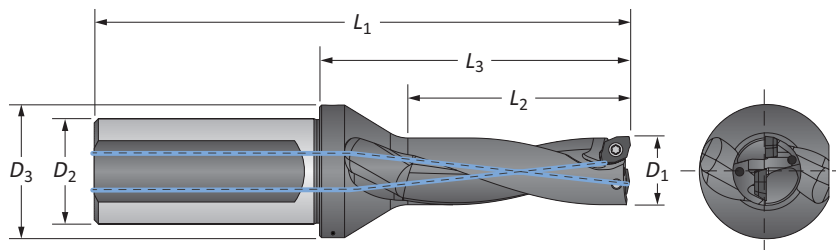

**Metric Shank**

Length	D <sub>1</sub>		Body			Shank		Max Offset	Part No.
	mm	in	L <sub>2</sub>	L <sub>3</sub>	L <sub>1</sub>	D <sub>2</sub>	D <sub>3</sub>		
2xD	15.50	0.610	31.00	54.50	108.50	25.00	32.00	0.80	D2051550M-25FM
	15.88	0.625	31.75	54.50	108.50	25.00	32.00	0.70	D2050625I-25FM
	16.00	0.630	32.00	55.50	109.50	25.00	32.00	0.70	D2051600M-25FM
	16.50	0.650	33.00	56.50	110.50	25.00	32.00	0.50	D2051650M-25FM
	16.66	0.656	33.32	56.49	110.50	25.00	32.00	0.40	D2050656I-25FM
	17.00	0.669	34.00	57.50	111.50	25.00	32.00	0.40	D2051700M-25FM
	17.46	0.687	34.90	57.50	111.50	25.00	32.00	0.30	D2050687I-25FM
	17.50	0.689	35.00	58.50	112.50	25.00	32.00	0.30	D2051750M-25FM
	18.00	0.709	36.00	59.50	113.50	25.00	32.00	0.20	D2051800M-25FM
18.24	0.718	36.47	59.51	113.51	25.00	32.00	0.15	D2050718I-25FM	
3xD	15.50	0.610	46.50	70.00	124.00	25.00	32.00	0.80	D3051550M-25FM
	15.88	0.625	47.63	70.00	124.00	25.00	32.00	0.70	D3050625I-25FM
	16.00	0.630	48.00	71.50	125.50	25.00	32.00	0.70	D3051600M-25FM
	16.50	0.650	49.50	73.00	127.00	25.00	32.00	0.50	D3051650M-25FM
	16.66	0.656	49.98	73.00	127.00	25.00	32.00	0.40	D3050656I-25FM
	17.00	0.669	51.00	74.50	128.50	25.00	32.00	0.40	D3051700M-25FM
	17.46	0.687	52.35	74.50	128.50	25.00	32.00	0.30	D3050687I-25FM
	17.50	0.689	52.50	76.00	130.00	25.00	32.00	0.30	D3051750M-25FM
	18.00	0.709	54.00	77.50	131.50	25.00	32.00	0.20	D3051800M-25FM
18.24	0.718	54.71	77.50	131.50	58.00	32.00	0.15	D3050718I-25FM	
4xD	15.50	0.610	62.00	85.50	139.50	25.00	32.00	0.80	D4051550M-25FM
	15.88	0.625	63.50	85.50	139.50	25.00	32.00	0.70	D4050625I-25FM
	16.00	0.630	64.00	87.50	141.50	25.00	32.00	0.70	D4051600M-25FM
	16.50	0.650	66.00	89.50	143.50	25.00	32.00	0.50	D4051650M-25FM
	16.66	0.656	66.64	89.51	143.51	25.00	32.00	0.40	D4050656I-25FM
	17.00	0.669	68.00	91.50	145.50	25.00	32.00	0.40	D4051700M-25FM
	17.46	0.687	69.80	91.50	145.50	25.00	32.00	0.30	D4050687I-25FM
	17.50	0.689	70.00	93.50	147.50	25.00	32.00	0.30	D4051750M-25FM
	18.00	0.709	72.00	95.50	149.50	25.00	32.00	0.20	D4051800M-25FM
18.24	0.718	72.95	95.50	149.50	25.00	32.00	0.15	D4050718I-25FM	

**IC Inserts**

ISO Material	Part No.	Insert Screw	Torx® Driver	Admissible Tightening Torque
P	4T-05T203-P	7243-T6-1	8T-6	0.5 N-m (4.4 in-lbs)
S	4T-05T203-M			
H	4T-05T203-H			
K	4T-05T203-K			
N	4T-05T203-N			

**Expected Hole Tolerances**

Length	mm	in
2xD	-0.10 / +0.20	-0.004 / +0.008
3xD	-0.10 / +0.20	-0.004 / +0.008
4xD	-0.10 / +0.25	-0.004 / +0.010

A55: 32 - 33

A55: 29 - 31

A55: 28

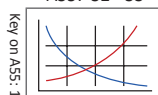

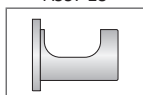

Key on A55: 1

 Ⓜ = Metric (mm)  
 ⓘ = Imperial (in)

 IC inserts sold in quantities of 10  
 Insert screws sold in quantities of 10

A55: 10

www.alliedmachine.com | +44 (0) 1384 400 900 | enquiries.eu@alliedmachine.com

A DRILLING

B BORING

C REAMING

D BURNISHING

E THREADING

X SPECIALS

4TEX Drill Holders | Imperial Shank

05 Series | Diameter Range: 15.50 mm - 18.49 mm (0.611" - 0.728")

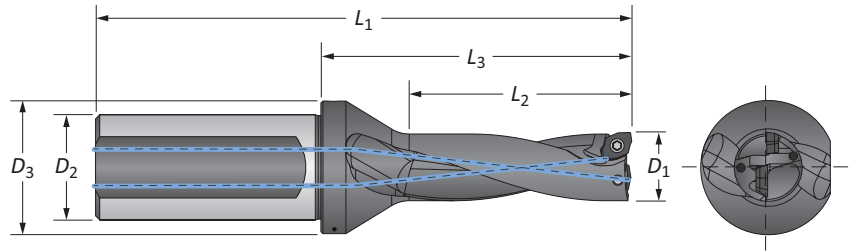

Imperial Shank

Length	D <sub>1</sub>		Body			Shank		Max Offset	Part No.
	mm	in	L <sub>2</sub>	L <sub>3</sub>	L <sub>1</sub>	D <sub>2</sub>	D <sub>3</sub>		
2xD	15.50	0.610	1.220	2.146	4.272	1.000	1.260	0.031	D2051550M-100F
	15.88	0.625	1.250	2.146	4.272	1.000	1.260	0.029	D2050625I-100F
	16.00	0.630	1.260	2.185	4.311	1.000	1.260	0.028	D2051600M-100F
	16.50	0.650	1.299	2.224	4.350	1.000	1.260	0.020	D2051650M-100F
	16.66	0.656	1.312	2.224	4.350	1.000	1.260	0.016	D2050656I-100F
	17.00	0.669	1.339	2.264	4.390	1.000	1.260	0.016	D2051700M-100F
	17.46	0.687	1.374	2.264	4.390	1.000	1.260	0.012	D2050687I-100F
	17.50	0.689	1.378	2.303	4.429	1.000	1.260	0.012	D2051750M-100F
	18.00	0.709	1.417	2.343	4.469	1.000	1.260	0.008	D2051800M-100F
3xD	18.24	0.718	1.436	2.343	4.469	1.000	1.260	0.006	D2050718I-100F
	15.50	0.610	1.831	2.756	4.882	1.000	1.260	0.031	D3051550M-100F
	15.88	0.625	1.875	2.756	4.882	1.000	1.260	0.029	D3050625I-100F
	16.00	0.630	1.890	2.815	4.941	1.000	1.260	0.028	D3051600M-100F
	16.50	0.650	1.949	2.874	5.000	1.000	1.260	0.020	D3051650M-100F
	16.66	0.656	1.968	2.784	5.000	1.000	1.260	0.016	D3050656I-100F
	17.00	0.669	2.008	2.933	5.059	1.000	1.260	0.016	D3051700M-100F
	17.46	0.687	2.061	2.933	5.059	1.000	1.260	0.012	D3050687I-100F
	17.50	0.689	2.067	2.992	5.118	1.000	1.260	0.012	D3051750M-100F
4xD	18.00	0.709	2.126	3.051	5.177	1.000	1.260	0.008	D3051800M-100F
	18.24	0.718	2.154	3.051	5.177	1.000	1.260	0.006	D3050718I-100F
	15.50	0.610	2.441	3.366	5.492	1.000	1.260	0.031	D4051550M-100F
	15.88	0.625	2.500	3.366	5.492	1.000	1.260	0.029	D4050625I-100F
	16.00	0.630	2.520	3.445	5.571	1.000	1.260	0.028	D4051600M-100F
	16.50	0.650	2.598	3.524	5.650	1.000	1.260	0.020	D4051650M-100F
	16.66	0.656	2.624	3.524	5.650	1.000	1.260	0.016	D4050656I-100F
	17.00	0.669	2.677	3.602	5.728	1.000	1.260	0.016	D4051700M-100F
	17.46	0.687	2.748	3.602	5.728	1.000	1.260	0.012	D4050687I-100F
17.50	0.689	2.756	3.681	5.807	1.000	1.260	0.012	D4051750M-100F	
18.00	0.709	2.835	3.760	5.886	1.000	1.260	0.008	D4051800M-100F	
18.24	0.718	2.872	3.760	5.886	1.000	1.260	0.006	D4050718I-100F	

IC Inserts

ISO Material	Part No.	Insert Screw	Torx® Driver	Admissible Tightening Torque
P	4T-05T203-P	7243-T6-1	8T-6	0.5 N-m (4.4 in-lbs)
S	4T-05T203-M			
H	4T-05T203-H			
K	4T-05T203-K			
N	4T-05T203-N			

Expected Hole Tolerances

Length	mm	in
2xD	-0.10 / +0.20	-0.004 / +0.008
3xD	-0.10 / +0.20	-0.004 / +0.008
4xD	-0.10 / +0.25	-0.004 / +0.010

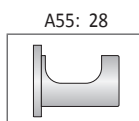
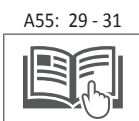
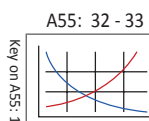

Ⓜ = Metric (mm)  
Ⓢ = Imperial (in)

IC inserts sold in quantities of 10  
Insert screws sold in quantities of 10

## 4TEX Drill Holders | Metric Shank

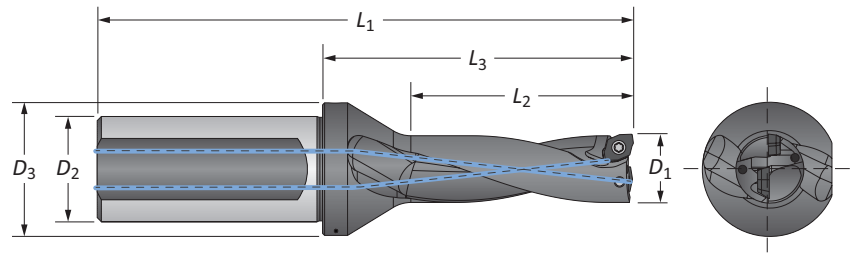

06 Series | Diameter Range: 18.50 mm - 21.99 mm (0.728" - 0.866")



### Metric Shank

Length	D <sub>1</sub>		Body			Shank		Max Offset	Part No.
	mm	in	L <sub>2</sub>	L <sub>3</sub>	L <sub>1</sub>	D <sub>2</sub>	D <sub>3</sub>		
2xD	18.50	0.728	37.00	58.40	112.40	25.00	32.00	0.90	D2061850M-25FM
	19.00	0.748	38.00	59.40	113.40	25.00	32.00	0.80	D2061900M-25FM
	19.05	0.750	38.10	59.40	113.40	25.00	32.00	0.80	D2060750I-25FM
	19.43	0.765	38.86	59.41	113.41	25.00	32.00	0.70	D2060765I-25FM
	19.50	0.768	39.00	60.40	114.40	25.00	32.00	0.70	D2061950M-25FM
	20.00	0.787	40.00	61.40	115.40	25.00	32.00	0.50	D2062000M-25FM
	20.50	0.807	41.00	62.40	116.40	25.00	32.00	0.40	D2062050M-25FM
	20.64	0.813	41.25	62.40	116.40	25.00	32.00	0.40	D2060812I-25FM
	21.00	0.827	42.00	63.40	117.40	25.00	32.00	0.30	D2062100M-25FM
	21.50	0.846	43.00	64.40	118.40	25.00	32.00	0.20	D2062150M-25FM
3xD	18.50	0.728	55.00	76.90	130.90	25.00	32.00	0.90	D3061850M-25FM
	19.00	0.748	57.00	78.40	132.40	25.00	32.00	0.80	D3061900M-25FM
	19.05	0.750	57.15	78.40	132.40	25.00	32.00	0.80	D3060750I-25FM
	19.43	0.765	58.29	78.41	132.41	25.00	32.00	0.70	D3060765I-25FM
	19.50	0.768	58.50	79.90	133.90	25.00	32.00	0.70	D3061950M-25FM
	20.00	0.787	60.00	81.40	135.40	25.00	32.00	0.50	D3062000M-25FM
	20.50	0.807	61.50	82.90	136.90	25.00	32.00	0.40	D3062050M-25FM
	20.64	0.813	61.87	82.90	136.90	25.00	32.00	0.40	D3060812I-25FM
	21.00	0.827	63.00	84.40	138.40	25.00	32.00	0.30	D3062100M-25FM
	21.50	0.846	64.50	85.90	139.90	25.00	32.00	0.20	D3062150M-25FM
4xD	18.50	0.728	74.00	95.40	149.40	25.00	32.00	0.90	D4061850M-25FM
	19.00	0.748	76.00	97.40	151.40	25.00	32.00	0.80	D4061900M-25FM
	19.05	0.750	76.20	97.40	151.40	25.00	32.00	0.80	D4060750I-25FM
	19.43	0.765	77.72	97.41	151.41	25.00	32.00	0.70	D4060765I-25FM
	19.50	0.768	78.00	99.40	153.40	25.00	32.00	0.70	D4061950M-25FM
	20.00	0.787	80.00	101.40	155.40	25.00	32.00	0.50	D4062000M-25FM
	20.50	0.807	82.00	103.40	157.40	25.00	32.00	0.40	D4062050M-25FM
	20.64	0.813	82.49	103.40	157.40	25.00	32.00	0.40	D4060812I-25FM
	21.00	0.827	84.00	105.40	159.40	25.00	32.00	0.30	D4062100M-25FM
	21.50	0.846	86.00	107.40	161.40	25.00	32.00	0.20	D4062150M-25FM

### IC Inserts

ISO Material	Part No.	 Insert Screw	 Torx® Driver	Admissible Tightening Torque
P	4T-06T204-P	72251-T7-1	8T-7	0.8 N-m (7.1 in-lbs)
S	4T-06T204-M			
H	4T-06T204-H			
K	4T-06T204-K			
N	4T-06T204-N			

### Expected Hole Tolerances

Length	mm	in
2xD	-0.10 / +0.20	-0.004 / +0.008
3xD	-0.10 / +0.20	-0.004 / +0.008
4xD	-0.10 / +0.25	-0.004 / +0.010

A55: 32 - 33

A55: 29 - 31

A55: 28

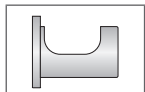
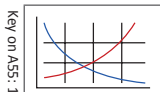

 = Metric (mm)

 = Imperial (in)

IC inserts sold in quantities of 10  
Insert screws sold in quantities of 10



## 4TEX Drill Holders | Imperial Shank

06 Series | Diameter Range: 18.50 mm - 21.99 mm (0.728" - 0.866")

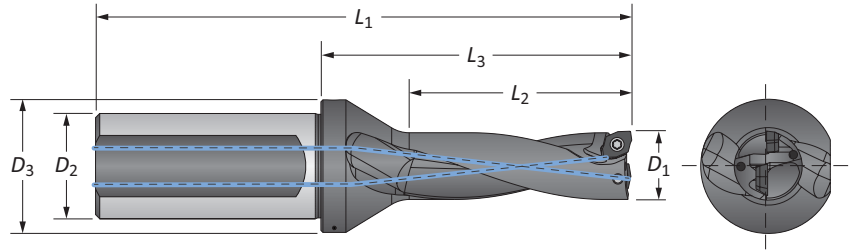

### Imperial Shank

Length	D <sub>1</sub>		Body			Shank		Max Offset	Part No.
	mm	in	L <sub>2</sub>	L <sub>3</sub>	L <sub>1</sub>	D <sub>2</sub>	D <sub>3</sub>		
2xD	18.50	0.728	1.457	2.299	4.425	1.000	1.260	0.035	D2061850M-100F
	19.00	0.748	1.496	2.339	4.465	1.000	1.260	0.031	D2061900M-100F
	19.05	0.750	1.500	2.339	4.465	1.000	1.260	0.031	D2060750I-100F
	19.43	0.765	1.530	2.339	4.465	1.000	1.260	0.028	D2060765I-100F
	19.50	0.768	1.535	2.378	4.504	1.000	1.260	0.028	D2061950M-100F
	20.00	0.787	1.575	2.417	4.543	1.000	1.260	0.020	D2062000M-100F
	20.50	0.807	1.614	2.457	4.583	1.000	1.260	0.016	D2062050M-100F
	20.64	0.813	1.624	2.457	4.583	1.000	1.260	0.015	D2060812I-100F
	21.00	0.827	1.654	2.496	4.622	1.000	1.260	0.012	D2062100M-100F
3xD	18.50	0.728	2.165	3.028	5.154	1.000	1.260	0.035	D3061850M-100F
	19.00	0.748	2.244	3.087	5.213	1.000	1.260	0.031	D3061900M-100F
	19.05	0.750	2.250	3.087	5.213	1.000	1.260	0.031	D3060750I-100F
	19.43	0.765	2.295	3.087	5.213	1.000	1.260	0.028	D3060765I-100F
	19.50	0.768	2.303	3.146	5.272	1.000	1.260	0.028	D3061950M-100F
	20.00	0.787	2.362	3.205	5.331	1.000	1.260	0.020	D3062000M-100F
	20.50	0.807	2.421	3.264	5.390	1.000	1.260	0.016	D3062050M-100F
	20.64	0.813	2.436	3.264	5.390	1.000	1.260	0.015	D3060812I-100F
	21.00	0.827	2.480	3.323	5.449	1.000	1.260	0.012	D3062100M-100F
4xD	18.50	0.728	2.913	3.756	5.882	1.000	1.260	0.035	D4061850M-100F
	19.00	0.748	2.992	3.835	5.961	1.000	1.260	0.031	D4061900M-100F
	19.05	0.750	3.000	3.835	5.961	1.000	1.260	0.031	D4060750I-100F
	19.43	0.765	3.060	3.835	5.961	1.000	1.260	0.028	D4060765I-100F
	19.50	0.768	3.071	3.913	6.039	1.000	1.260	0.028	D4061950M-100F
	20.00	0.787	3.150	3.992	6.118	1.000	1.260	0.020	D4062000M-100F
	20.50	0.807	3.228	4.071	6.197	1.000	1.260	0.016	D4062050M-100F
	20.64	0.813	3.248	4.071	6.197	1.000	1.260	0.015	D4060812I-100F
	21.00	0.827	3.307	4.150	6.276	1.000	1.260	0.012	D4062100M-100F
21.50	0.846	3.386	4.228	6.354	1.000	1.260	0.008	D4062150M-100F	

### IC Inserts

ISO Material	Part No.	Insert Screw	Torx® Driver	Admissible Tightening Torque
P	4T-06T204-P	72251-T7-1	8T-7	0.8 N-m (7.1 in-lbs)
S	4T-06T204-M			
H	4T-06T204-H			
K	4T-06T204-K			
N	4T-06T204-N			

### Expected Hole Tolerances

Length	mm	in
2xD	-0.10 / +0.20	-0.004 / +0.008
3xD	-0.10 / +0.20	-0.004 / +0.008
4xD	-0.10 / +0.25	-0.004 / +0.010

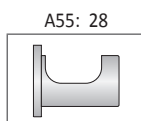
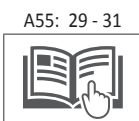
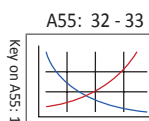

m = Metric (mm)  
i = Imperial (in)

IC inserts sold in quantities of 10  
Insert screws sold in quantities of 10

07

 DRILLING | 4TEX® Drill: Indexable Carbide Insert Drilling System

## 4TEX Drill Holders | Metric Shank

07 Series | Diameter Range: 22.00 mm - 26.49 mm (0.867" - 1.043")



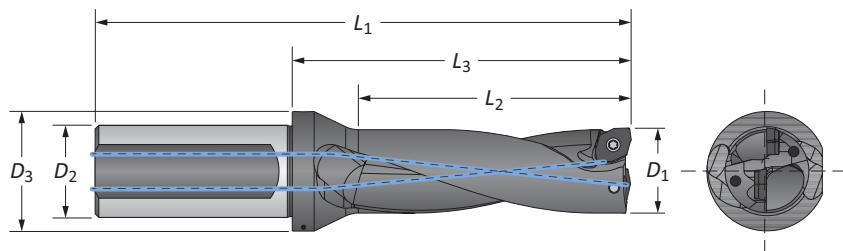

Metric Shank

Length	D <sub>1</sub>		Body			Shank		Max Offset	Part No.
	mm	in	L <sub>2</sub>	L <sub>3</sub>	L <sub>1</sub>	D <sub>2</sub>	D <sub>3</sub>		
2xD	22.00	0.866	44.00	64.90	118.90	25.00	33.00	1.20	D2072200M-25FM
	22.22	0.875	44.45	64.90	118.90	25.00	33.00	1.10	D2070875I-25FM
	22.50	0.886	45.00	65.90	119.90	25.00	33.00	1.00	D2072250M-25FM
	23.00	0.906	46.00	66.90	120.90	25.00	33.00	0.90	D2072300M-25FM
	23.50	0.925	47.00	67.90	121.90	25.00	33.00	0.80	D2072350M-25FM
	23.81	0.937	47.60	67.90	121.90	25.00	33.00	7.40	D2070937I-25FM
	24.00	0.945	48.00	68.90	122.90	25.00	33.00	0.70	D2072400M-25FM
	24.50	0.965	49.00	69.90	123.90	25.00	33.00	0.50	D2072450M-25FM
	25.00	0.984	50.00	70.90	124.90	25.00	33.00	0.40	D2072500M-25FM
	25.40	1.000	50.80	70.90	124.90	25.00	33.00	0.30	D2071000I-25FM
25.50	1.004	51.00	71.90	125.90	25.00	33.00	0.30	D2072550M-25FM	
26.00	1.024	52.00	72.90	126.90	25.00	33.00	0.20	D2072600M-25FM	
3xD	22.00	0.866	66.00	86.90	140.90	25.00	33.00	1.20	D3072200M-25FM
	22.22	0.875	66.68	86.90	140.90	25.00	33.00	1.10	D3070875I-25FM
	22.50	0.886	67.50	88.40	142.40	25.00	33.00	1.00	D3072250M-25FM
	23.00	0.906	69.00	89.90	143.90	25.00	33.00	0.90	D3072300M-25FM
	23.50	0.925	70.50	91.40	145.40	25.00	33.00	0.80	D3072350M-25FM
	23.81	0.937	71.40	91.40	145.40	25.00	33.00	7.40	D3070937I-25FM
	24.00	0.945	72.00	92.90	146.90	25.00	33.00	0.70	D3072400M-25FM
	24.50	0.965	73.50	94.40	148.40	25.00	33.00	0.50	D3072450M-25FM
	25.00	0.984	75.00	95.90	149.90	25.00	33.00	0.40	D3072500M-25FM
	25.40	1.000	76.20	95.90	149.90	25.00	33.00	0.30	D3071000I-25FM
25.50	1.004	76.50	97.00	151.00	25.00	33.00	0.30	D3072550M-25FM	
26.00	1.024	78.00	99.00	153.00	25.00	33.00	0.20	D3072600M-25FM	
4xD	22.00	0.866	88.00	109.00	163.00	25.00	33.00	1.20	D4072200M-25FM
	22.22	0.875	88.90	108.90	162.90	25.00	33.00	1.10	D4070875I-25FM
	22.50	0.886	90.00	111.00	165.00	25.00	33.00	1.00	D4072250M-25FM
	23.00	0.906	92.00	113.00	167.00	25.00	33.00	0.90	D4072300M-25FM
	23.50	0.925	94.00	115.00	169.00	25.00	33.00	0.80	D4072350M-25FM
	23.81	0.937	95.20	114.90	168.90	25.00	33.00	7.40	D4070937I-25FM
	24.00	0.945	96.00	117.00	171.00	25.00	33.00	0.70	D4072400M-25FM
	24.50	0.965	98.00	119.00	173.00	25.00	33.00	0.50	D4072450M-25FM
	25.00	0.984	100.00	121.00	175.00	25.00	33.00	0.40	D4072500M-25FM
	25.40	1.000	101.60	120.90	174.90	25.00	33.00	0.30	D4071000I-25FM
25.50	1.004	102.00	123.00	177.00	25.00	33.00	0.30	D4072550M-25FM	
26.00	1.024	104.00	125.00	179.00	25.00	33.00	0.20	D4072600M-25FM	

IC Inserts

ISO Material	Part No.	Insert Screw	Torx® Driver	Admissible Tightening Torque
P	4T-070305-P	72568-T8-1	8T-8	1.2 N-m (10.6 in-lbs)
S	4T-070305-M			
H	4T-070305-H			
K	4T-070305-K			
N	4T-070305-N			

Expected Hole Tolerances

Length	mm	in
2xD	-0.10 / +0.20	-0.004 / +0.008
3xD	-0.10 / +0.20	-0.004 / +0.008
4xD	-0.10 / +0.25	-0.004 / +0.010

A55: 32 - 33

A55: 29 - 31

A55: 28

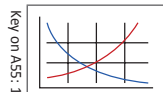

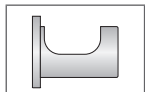
 = Metric (mm)

 = Imperial (in)

 IC inserts sold in quantities of 10  
 Insert screws sold in quantities of 10

A55: 14

[www.alliedmachine.com](http://www.alliedmachine.com) | +44 (0) 1384 400 900 | [enquiries.eu@alliedmachine.com](mailto:enquiries.eu@alliedmachine.com)

A DRILLING

B BORING

C REAMING

D BURNISHING

E THREADING

X SPECIALS

4TEX Drill Holders | Imperial Shank

07 Series | Diameter Range: 22.00 mm - 26.49 mm (0.867" - 1.043")

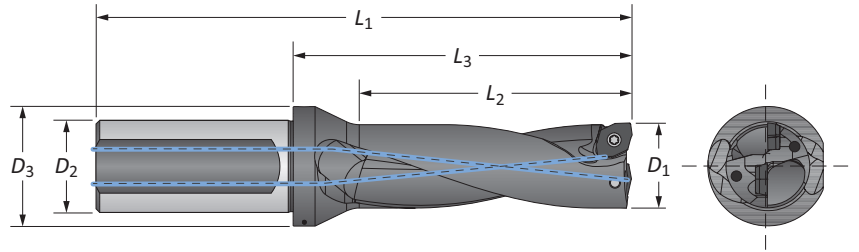

Imperial Shank

Length	D <sub>1</sub>		Body			Shank		Max Offset	Part No.
	mm	in	L <sub>2</sub>	L <sub>3</sub>	L <sub>1</sub>	D <sub>2</sub>	D <sub>3</sub>		
2xD	22.00	0.866	1.732	2.555	4.681	1.000	1.299	0.047	D2072200M-100F
	22.22	0.875	1.750	2.555	4.681	1.000	1.299	0.043	D2070875I-100F
	22.50	0.886	1.772	2.594	4.720	1.000	1.299	0.039	D2072250M-100F
	23.00	0.906	1.811	2.634	4.760	1.000	1.299	0.035	D2072300M-100F
	23.50	0.925	1.850	2.673	4.799	1.000	1.299	0.031	D2072350M-100F
	23.81	0.937	1.874	2.673	4.799	1.000	1.299	0.292	D2070937I-100F
	24.00	0.945	1.890	2.713	4.839	1.000	1.299	0.028	D2072400M-100F
	24.50	0.965	1.929	2.752	4.878	1.000	1.299	0.020	D2072450M-100F
	25.00	0.984	1.969	2.791	4.917	1.000	1.299	0.016	D2072500M-100F
	25.40	1.000	2.000	2.791	4.917	1.000	1.299	0.013	D2071000I-100F
3xD	22.00	0.866	2.598	3.421	5.547	1.000	1.299	0.047	D3072200M-100F
	22.22	0.875	2.625	3.421	5.547	1.000	1.299	0.043	D3070875I-100F
	22.50	0.886	2.657	3.480	5.606	1.000	1.299	0.039	D3072250M-100F
	23.00	0.906	2.717	3.539	5.665	1.000	1.299	0.035	D3072300M-100F
	23.50	0.925	2.776	3.598	5.724	1.000	1.299	0.031	D3072350M-100F
	23.81	0.937	2.811	3.598	5.724	1.000	1.299	0.292	D3070937I-100F
	24.00	0.945	2.835	3.657	5.783	1.000	1.299	0.028	D3072400M-100F
	24.50	0.965	2.894	3.717	5.843	1.000	1.299	0.020	D3072450M-100F
	25.00	0.984	2.953	3.776	5.902	1.000	1.299	0.016	D3072500M-100F
	25.40	1.000	3.000	3.776	5.902	1.000	1.299	0.013	D3071000I-100F
4xD	22.00	0.866	3.465	4.287	6.413	1.000	1.299	0.047	D4072200M-100F
	22.22	0.875	3.500	4.287	6.413	1.000	1.299	0.043	D4070875I-100F
	22.50	0.886	3.543	4.366	6.492	1.000	1.299	0.039	D4072250M-100F
	23.00	0.906	3.622	4.445	6.571	1.000	1.299	0.035	D4072300M-100F
	23.50	0.925	3.701	4.524	6.650	1.000	1.299	0.031	D4072350M-100F
	23.81	0.937	3.748	4.524	6.650	1.000	1.299	0.292	D4070937I-100F
	24.00	0.945	3.780	4.602	6.728	1.000	1.299	0.028	D4072400M-100F
	24.50	0.965	3.858	4.681	6.807	1.000	1.299	0.020	D4072450M-100F
	25.00	0.984	3.937	4.760	6.886	1.000	1.299	0.016	D4072500M-100F
	25.40	1.000	4.000	4.760	6.886	1.000	1.299	0.013	D4071000I-100F
4xD	25.50	1.004	4.016	4.839	6.965	1.000	1.299	0.012	D4072550M-100F
	26.00	1.024	4.094	4.917	7.043	1.000	1.299	0.008	D4072600M-100F

IC Inserts

ISO Material	Part No.	Insert Screw	Torx® Driver	Admissible Tightening Torque
P	4T-070305-P	72568-T8-1	8T-8	1.2 N-m (10.6 in-lbs)
S	4T-070305-M			
H	4T-070305-H			
K	4T-070305-K			
N	4T-070305-N			

Expected Hole Tolerances

Length	mm	in
2xD	-0.10 / +0.20	-0.004 / +0.008
3xD	-0.10 / +0.20	-0.004 / +0.008
4xD	-0.10 / +0.25	-0.004 / +0.010

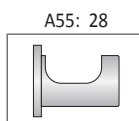
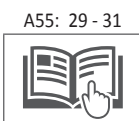
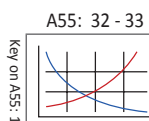

Ⓜ = Metric (mm)  
Ⓢ = Imperial (in)

IC inserts sold in quantities of 10  
Insert screws sold in quantities of 10

## 4TEX Drill Holders | Metric Shank

09 Series | Diameter Range: 26.50 mm - 31.99 mm (1.044" - 1.259")

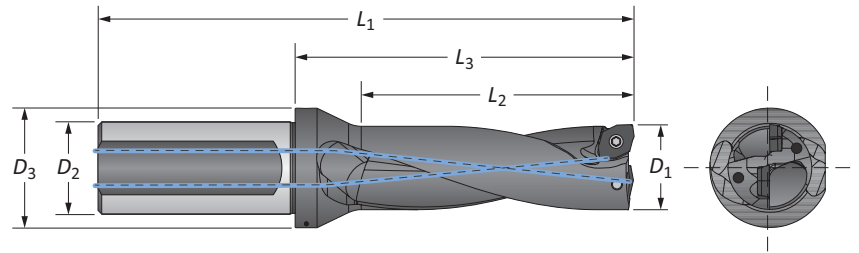

### Metric Shank

Length	D <sub>1</sub>		Body			Shank		Max Offset	Part No.
	mm	in	L <sub>2</sub>	L <sub>3</sub>	L <sub>1</sub>	D <sub>2</sub>	D <sub>3</sub>		
2xD	26.50	1.043	53.00	75.70	134.70	32.00	41.00	1.68	D2092650M-32FM
	27.00	1.063	54.00	76.70	135.70	32.00	41.00	1.60	D2092700M-32FM
	27.50	1.083	55.00	77.70	136.70	32.00	41.00	1.45	D2092750M-32FM
	28.00	1.102	56.00	78.70	137.70	32.00	41.00	1.30	D2092800M-32FM
	28.50	1.122	57.00	79.70	138.70	32.00	41.00	1.21	D2092850M-32FM
	28.58	1.125	57.15	79.70	138.70	32.00	41.00	1.20	D2091125I-32FM
	29.00	1.142	58.00	80.70	139.70	32.00	41.00	1.10	D2092900M-32FM
	29.50	1.161	59.00	81.70	140.70	32.00	43.00	0.97	D2092950M-32FM
	30.00	1.181	60.00	82.70	141.70	32.00	43.00	0.80	D2093000M-32FM
	30.15	1.187	60.30	82.70	141.70	32.00	43.00	0.82	D2091187I-32FM
	30.50	1.201	61.00	83.70	142.70	32.00	43.00	0.74	D2093050M-32FM
	31.00	1.220	62.00	84.70	143.70	32.00	43.00	0.60	D2093100M-32FM
	31.50	1.240	63.00	85.70	144.70	32.00	43.00	0.50	D2093150M-32FM
	31.75	1.250	63.50	85.70	144.70	32.00	43.00	0.50	D2091250I-32FM
3xD	26.50	1.043	79.50	102.20	161.20	32.00	41.00	1.68	D3092650M-32FM
	27.00	1.063	81.00	103.70	162.70	32.00	41.00	1.60	D3092700M-32FM
	27.50	1.083	82.50	105.20	164.20	32.00	41.00	1.45	D3092750M-32FM
	28.00	1.102	84.00	106.70	165.70	32.00	41.00	1.30	D3092800M-32FM
	28.50	1.122	85.50	108.20	167.20	32.00	41.00	1.21	D3092850M-32FM
	28.58	1.125	85.73	108.20	167.20	32.00	41.00	1.20	D3091125I-32FM
	29.00	1.142	87.00	109.70	168.70	32.00	41.00	1.10	D3092900M-32FM
	29.50	1.161	88.50	111.20	170.20	32.00	43.00	0.97	D3092950M-32FM
	30.00	1.181	90.00	112.70	171.70	32.00	43.00	0.80	D3093000M-32FM
	30.15	1.187	90.45	112.70	171.70	32.00	43.00	0.82	D3091187I-32FM
	30.50	1.201	91.50	114.20	173.20	32.00	43.00	0.74	D3093050M-32FM
	31.00	1.220	93.00	115.70	174.70	32.00	43.00	0.60	D3093100M-32FM
	31.50	1.240	94.50	117.00	176.20	32.00	43.00	0.50	D3093150M-32FM
	31.75	1.250	95.25	117.20	176.20	32.00	43.00	0.50	D3091250I-32FM

### IC Inserts

ISO Material	Part No.	Insert Screw	Torx® Driver	Admissible Tightening Torque
P	4T-09T306-P	738-T10-1	8T-10	2.0 N-m (17.7 in-lbs)
S	4T-09T306-M			
H	4T-09T306-H			
K	4T-09T306-K			
N	4T-09T306-N			

### Expected Hole Tolerances

Length	mm	in
2xD	-0.15 / +0.25	-0.006 / +0.010
3xD	-0.15 / +0.25	-0.006 / +0.010
4xD	-0.15 / +0.30	-0.006 / +0.012

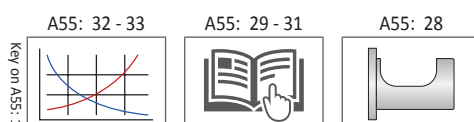

 = Metric (mm)  
 = Imperial (in)

IC inserts sold in quantities of 10  
Insert screws sold in quantities of 10

4TEX Drill Holders | Metric Shank

09 Series | Diameter Range: 26.50 mm - 31.99 mm (1.044" - 1.259")

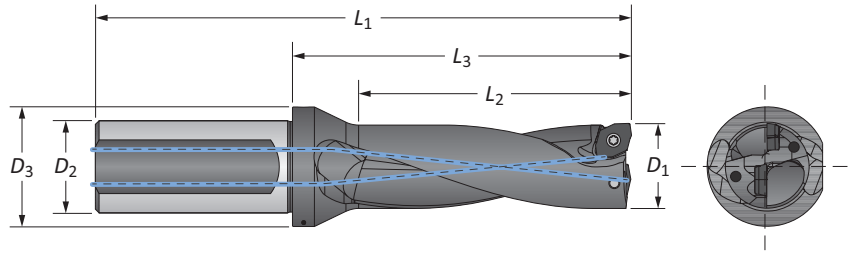

Metric Shank

Length	D <sub>1</sub>		Body			Shank		Max Offset	Part No.
	mm	in	L <sub>2</sub>	L <sub>3</sub>	L <sub>1</sub>	D <sub>2</sub>	D <sub>3</sub>		
4xD	26.50	1.043	106.00	128.70	187.70	32.00	41.00	1.68	D4092650M-32FM
	27.00	1.063	108.00	130.70	189.70	32.00	41.00	1.60	D4092700M-32FM
	27.50	1.083	110.00	132.70	191.70	32.00	41.00	1.45	D4092750M-32FM
	28.00	1.102	112.00	134.70	193.70	32.00	41.00	1.30	D4092800M-32FM
	28.50	1.122	114.00	136.70	195.70	32.00	41.00	1.21	D4092850M-32FM
	28.58	1.125	114.30	136.70	195.70	32.00	41.00	1.20	D4091125I-32FM
	29.00	1.142	116.00	138.70	197.70	32.00	41.00	1.10	D4092900M-32FM
	29.50	1.161	118.00	140.70	199.70	32.00	43.00	0.97	D4092950M-32FM
	30.00	1.181	120.00	142.70	201.70	32.00	43.00	0.80	D4093000M-32FM
	30.15	1.187	120.60	142.70	201.70	32.00	43.00	0.82	D4091187I-32FM
	30.50	1.201	122.00	144.70	203.70	32.00	43.00	0.74	D4093050M-32FM
	31.00	1.220	124.00	146.70	205.70	32.00	43.00	0.60	D4093100M-32FM
	31.50	1.240	126.00	148.70	207.70	32.00	43.00	0.50	D4093150M-32FM
31.75	1.250	127.00	148.70	207.70	32.00	43.00	0.50	D4091250I-32FM	

IC Inserts

ISO Material	Part No.	Insert Screw	Torx® Driver	Admissible Tightening Torque
P	4T-09T306-P	738-T10-1	8T-10	2.0 N-m (17.7 in-lbs)
S	4T-09T306-M			
H	4T-09T306-H			
K	4T-09T306-K			
N	4T-09T306-N			

Expected Hole Tolerances

Length	mm	in
2xD	-0.15 / +0.25	-0.006 / +0.010
3xD	-0.15 / +0.25	-0.006 / +0.010
4xD	-0.15 / +0.30	-0.006 / +0.012

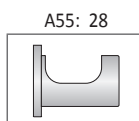
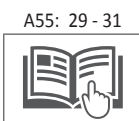
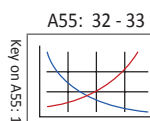

m = Metric (mm)  
i = Imperial (in)

IC inserts sold in quantities of 10  
Insert screws sold in quantities of 10

## 4TEX Drill Holders | Imperial Shank

09 Series | Diameter Range: 26.50 mm - 31.99 mm (1.044" - 1.259")

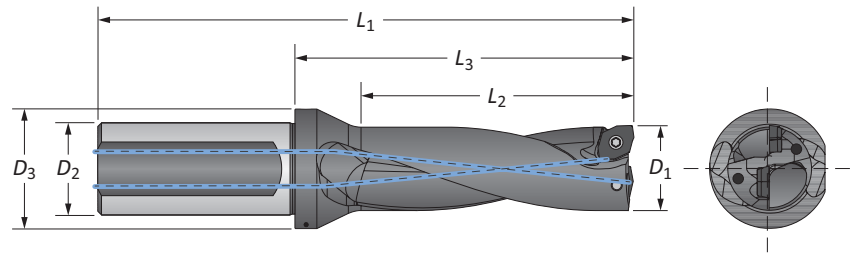

### Imperial Shank

Length	D <sub>1</sub>		Body			Shank		Max Offset	Part No.
	mm	in	L <sub>2</sub>	L <sub>3</sub>	L <sub>1</sub>	D <sub>2</sub>	D <sub>3</sub>		
2xD	26.50	1.043	2.087	2.980	5.303	1.250	1.614	0.066	D2092650M-125F
	27.00	1.063	2.126	3.020	5.343	1.250	1.614	0.063	D2092700M-125F
	27.50	1.083	2.165	3.059	5.382	1.250	1.614	0.057	D2092750M-125F
	28.00	1.102	2.205	3.098	5.421	1.250	1.614	0.051	D2092800M-125F
	28.50	1.122	2.244	3.138	5.461	1.250	1.614	0.048	D2092850M-125F
	28.58	1.125	2.250	3.138	5.461	1.250	1.614	0.046	D2091125I-125F
	29.00	1.142	2.283	3.177	5.500	1.250	1.614	0.043	D2092900M-125F
	29.50	1.161	2.323	3.217	5.539	1.250	1.693	0.038	D2092950M-125F
	30.00	1.181	2.362	3.256	5.579	1.250	1.693	0.031	D2093000M-125F
	30.15	1.187	2.374	3.256	5.579	1.250	1.693	0.032	D2091187I-125F
	30.50	1.201	2.402	3.295	5.618	1.250	1.693	0.029	D2093050M-125F
	31.00	1.220	2.441	3.335	5.657	1.250	1.693	0.024	D2093100M-125F
	31.50	1.240	2.480	3.374	5.697	1.250	1.693	0.020	D2093150M-125F
	31.75	1.250	2.500	3.374	5.697	1.250	1.693	0.019	D2091250I-125F
3xD	26.50	1.043	3.130	4.024	6.346	1.250	1.614	0.066	D3092650M-125F
	27.00	1.063	3.189	4.083	6.406	1.250	1.614	0.063	D3092700M-125F
	27.50	1.083	3.248	4.142	6.465	1.250	1.614	0.057	D3092750M-125F
	28.00	1.102	3.307	4.201	6.524	1.250	1.614	0.051	D3092800M-125F
	28.50	1.122	3.366	4.260	6.583	1.250	1.614	0.048	D3092850M-125F
	28.58	1.125	3.375	4.260	6.583	1.250	1.614	0.046	D3091125I-125F
	29.00	1.142	3.425	4.319	6.642	1.250	1.614	0.043	D3092900M-125F
	29.50	1.161	3.484	4.378	6.701	1.250	1.693	0.038	D3092950M-125F
	30.00	1.181	3.543	4.437	6.760	1.250	1.693	0.031	D3093000M-125F
	30.15	1.187	3.561	4.437	6.760	1.250	1.693	0.032	D3091187I-125F
	30.50	1.201	3.602	4.496	6.819	1.250	1.693	0.029	D3093050M-125F
	31.00	1.220	3.661	4.555	6.878	1.250	1.693	0.024	D3093100M-125F
	31.50	1.240	3.720	4.614	6.937	1.250	1.693	0.020	D3093150M-125F
	31.75	1.250	3.750	4.614	6.937	1.250	1.693	0.019	D3091250I-125F

### IC Inserts

ISO Material	Part No.	Insert Screw	Torx® Driver	Admissible Tightening Torque
P	4T-09T306-P	738-T10-1	8T-10	2.0 N-m (17.7 in-lbs)
S	4T-09T306-M			
H	4T-09T306-H			
K	4T-09T306-K			
N	4T-09T306-N			

### Expected Hole Tolerances

Length	mm	in
2xD	-0.15 / +0.25	-0.006 / +0.010
3xD	-0.15 / +0.25	-0.006 / +0.010
4xD	-0.15 / +0.30	-0.006 / +0.012

A55: 32 - 33

A55: 29 - 31

A55: 28

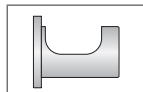
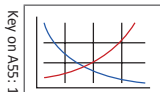

Key on A55: 1

m = Metric (mm)

i = Imperial (in)

IC inserts sold in quantities of 10  
Insert screws sold in quantities of 10

4TEX Drill Holders | Imperial Shank

09 Series | Diameter Range: 26.50 mm - 31.99 mm (1.044" - 1.259")

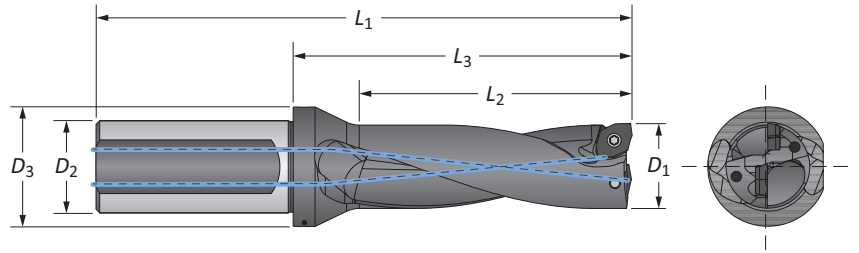

Imperial Shank

Length	D <sub>1</sub>		Body			Shank		Max Offset	Part No.
	mm	in	L <sub>2</sub>	L <sub>3</sub>	L <sub>1</sub>	D <sub>2</sub>	D <sub>3</sub>		
4xD	26.50	1.043	4.173	5.067	7.390	1.250	1.614	0.066	D4092650M-125F
	27.00	1.063	4.252	5.146	7.469	1.250	1.614	0.063	D4092700M-125F
	27.50	1.083	4.331	5.224	7.547	1.250	1.614	0.057	D4092750M-125F
	28.00	1.102	4.409	5.303	7.626	1.250	1.614	0.051	D4092800M-125F
	28.50	1.122	4.488	5.382	7.705	1.250	1.614	0.048	D4092850M-125F
	28.58	1.125	4.500	5.382	7.705	1.250	1.614	0.046	D4091125I-125F
	29.00	1.142	4.567	5.461	7.783	1.250	1.614	0.043	D4092900M-125F
	29.50	1.161	4.646	5.539	7.862	1.250	1.693	0.038	D4092950M-125F
	30.00	1.181	4.724	5.618	7.941	1.250	1.693	0.031	D4093000M-125F
	30.15	1.187	4.748	5.618	7.941	1.250	1.693	0.032	D4091187I-125F
	30.50	1.201	4.803	5.697	8.020	1.250	1.693	0.029	D4093050M-125F
	31.00	1.220	4.882	5.776	8.098	1.250	1.693	0.024	D4093100M-125F
	31.50	1.240	4.961	5.854	8.177	1.250	1.693	0.020	D4093150M-125F
31.75	1.250	5.000	5.854	8.177	1.250	1.693	0.019	D4091250I-125F	

IC Inserts

ISO Material	Part No.	Insert Screw	Torx® Driver	Admissible Tightening Torque
P	4T-09T306-P	738-T10-1	8T-10	2.0 N-m (17.7 in-lbs)
S	4T-09T306-M			
H	4T-09T306-H			
K	4T-09T306-K			
N	4T-09T306-N			

Expected Hole Tolerances

Length	mm	in
2xD	-0.15 / +0.25	-0.006 / +0.010
3xD	-0.15 / +0.25	-0.006 / +0.010
4xD	-0.15 / +0.30	-0.006 / +0.012

Key on ASS: 1

A55: 32 - 33

A55: 29 - 31

A55: 28

m = Metric (mm)  
i = Imperial (in)

IC inserts sold in quantities of 10  
Insert screws sold in quantities of 10

## 4TEX Drill Holders | Metric Shank

11 Series | Diameter Range: 32.00 mm - 38.99 mm (1.260" - 1.535")

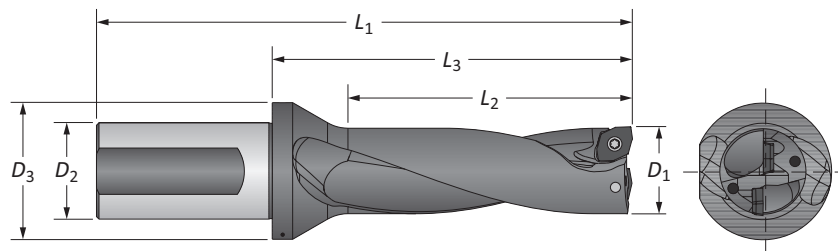

### Metric Shank

Length	D <sub>1</sub>		Body			Shank		Max Offset	Part No.
	mm	in	L <sub>2</sub>	L <sub>3</sub>	L <sub>1</sub>	D <sub>2</sub>	D <sub>3</sub>		
2xD	32.00	1.260	64.00	100.40	169.40	40.00	54.00	2.20	D2113200M-40FM
	32.50	1.280	65.00	100.40	169.40	40.00	54.00	2.05	D2113250M-40FM
	33.00	1.299	66.00	102.40	171.40	40.00	54.00	1.90	D2113300M-40FM
	33.32	1.312	66.65	102.40	171.40	40.00	54.00	1.84	D2111312I-40FM
	33.50	1.319	67.00	102.40	171.40	40.00	54.00	1.80	D2113350M-40FM
	34.00	1.339	68.00	104.40	173.40	40.00	54.00	1.70	D2113400M-40FM
	34.50	1.358	69.00	104.40	173.40	40.00	54.00	1.55	D2113450M-40FM
	34.92	1.375	69.85	104.40	173.40	40.00	54.00	1.42	D2111375I-40FM
	35.00	1.378	70.00	106.40	175.40	40.00	54.00	1.40	D2113500M-40FM
	35.50	1.398	71.00	106.40	175.40	40.00	54.00	1.30	D2113550M-40FM
	36.00	1.417	72.00	108.40	177.40	40.00	54.00	1.20	D2113600M-40FM
	36.50	1.437	73.00	108.40	177.40	40.00	54.00	1.06	D2113650M-40FM
	37.00	1.457	74.00	110.40	179.40	40.00	54.00	0.90	D2113700M-40FM
	37.50	1.476	75.00	110.40	179.40	40.00	54.00	0.81	D2113750M-40FM
	38.00	1.496	76.00	112.40	181.40	40.00	54.00	0.70	D2113800M-40FM
	38.10	1.500	76.20	112.40	181.40	40.00	54.00	0.69	D2111500I-40FM
38.50	1.516	77.00	112.40	181.40	40.00	54.00	0.56	D2113850M-40FM	
3xD	32.00	1.260	96.00	132.40	201.40	40.00	54.00	2.20	D3113200M-40FM
	32.50	1.280	97.50	132.40	201.40	40.00	54.00	2.05	D3113250M-40FM
	33.00	1.299	99.00	135.40	204.40	40.00	54.00	1.90	D3113300M-40FM
	33.32	1.312	99.97	135.40	204.40	40.00	54.00	1.84	D3111312I-40FM
	33.50	1.319	100.50	135.40	204.40	40.00	54.00	1.80	D3113350M-40FM
	34.00	1.339	102.00	138.40	207.40	40.00	54.00	1.70	D3113400M-40FM
	34.50	1.358	103.50	138.40	207.40	40.00	54.00	1.55	D3113450M-40FM
	34.92	1.375	104.78	138.40	207.40	40.00	54.00	1.42	D3111375I-40FM
	35.00	1.378	105.00	141.40	210.40	40.00	54.00	1.40	D3113500M-40FM
	35.50	1.398	106.50	141.40	210.40	40.00	54.00	1.30	D3113550M-40FM
	36.00	1.417	108.00	144.40	213.40	40.00	54.00	1.20	D3113600M-40FM
	36.50	1.437	109.50	144.40	213.40	40.00	54.00	1.06	D3113650M-40FM
	37.00	1.457	111.00	147.40	216.40	40.00	54.00	0.90	D3113700M-40FM
	37.50	1.476	112.50	147.40	216.40	40.00	54.00	0.81	D3113750M-40FM
	38.00	1.496	114.00	150.40	219.40	40.00	54.00	0.70	D3113800M-40FM
	38.10	1.500	114.30	150.40	219.40	40.00	54.00	0.69	D3111500I-40FM
38.50	1.516	115.50	150.40	219.40	40.00	54.00	0.56	D3113850M-150F	

### IC Inserts

ISO Material	Part No.	Insert Screw	Torx® Driver	Admissible Tightening Torque
P	4T-11T306-P	7488-T15-1	8T-15	3.5 N-m (30.9 in-lbs)
S	4T-11T306-M			
H	4T-11T306-H			
K	4T-11T306-K			
N	4T-11T306-N			

### Expected Hole Tolerances

Length	mm	in
2xD	-0.15 / +0.25	-0.006 / +0.010
3xD	-0.15 / +0.25	-0.006 / +0.010
4xD	-0.15 / +0.30	-0.006 / +0.012

A55: 32 - 33

A55: 29 - 31

A55: 28

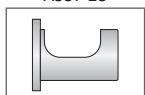
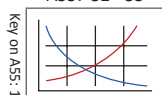

Ⓜ = Metric (mm)  
Ⓢ = Imperial (in)

IC inserts sold in quantities of 10  
Insert screws sold in quantities of 10



## 4TEX Drill Holders | Metric Shank

11 Series | Diameter Range: 32.00 mm - 38.99 mm (1.260" - 1.535")

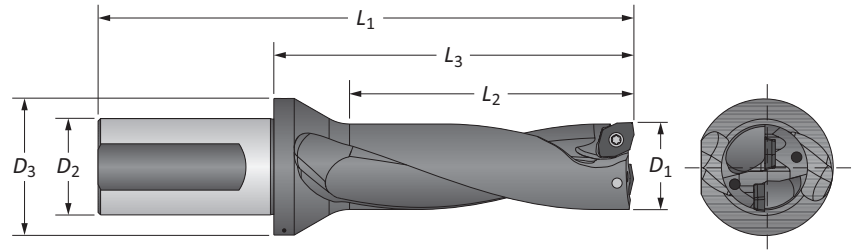

### Metric Shank

Length	D <sub>1</sub>		Body			Shank		Max Offset	Part No.
	mm	in	L <sub>2</sub>	L <sub>3</sub>	L <sub>1</sub>	D <sub>2</sub>	D <sub>3</sub>		
m 4xD	32.00	1.260	128.00	154.40	223.40	40.00	54.00	2.20	D4113200M-40FM
	32.50	1.280	130.00	154.40	223.40	40.00	54.00	2.05	D4113250M-40FM
	33.00	1.299	132.00	158.40	227.40	40.00	54.00	1.90	D4113300M-40FM
	33.32	1.312	133.30	158.40	227.40	40.00	54.00	1.84	D4111312I-40FM
	33.50	1.319	134.00	158.40	227.40	40.00	54.00	1.80	D4113350M-40FM
	34.00	1.339	136.00	162.40	231.40	40.00	54.00	1.70	D4113400M-40FM
	34.50	1.358	138.00	162.40	231.40	40.00	54.00	1.55	D4113450M-40FM
	34.92	1.375	139.70	162.40	231.40	40.00	54.00	1.42	D4111375I-40FM
	35.00	1.378	140.00	166.40	235.40	40.00	54.00	1.40	D4113500M-40FM
	35.50	1.398	142.00	166.40	235.40	40.00	54.00	1.30	D4113550M-40FM
	36.00	1.417	144.00	170.40	239.40	40.00	54.00	1.20	D4113600M-40FM
	36.50	1.437	146.00	170.40	239.40	40.00	54.00	1.06	D4113650M-40FM
	37.00	1.457	148.00	174.40	243.40	40.00	54.00	0.90	D4113700M-40FM
	37.50	1.476	150.00	174.40	243.40	40.00	54.00	0.81	D4113750M-40FM
	38.00	1.496	152.00	178.40	247.40	40.00	54.00	0.70	D4113800M-40FM
	38.10	1.500	152.40	178.40	247.40	40.00	54.00	0.69	D4111500I-40FM
38.50	1.516	154.00	178.40	247.40	40.00	54.00	0.56	D4113850M-40FM	

### IC Inserts

ISO Material	Part No.	Insert Screw	Torx® Driver	Admissible Tightening Torque
P	4T-11T306-P	7488-T15-1	8T-15	3.5 N-m (30.9 in-lbs)
S	4T-11T306-M			
H	4T-11T306-H			
K	4T-11T306-K			
N	4T-11T306-N			

### Expected Hole Tolerances

Length	mm	in
2xD	-0.15 / +0.25	-0.006 / +0.010
3xD	-0.15 / +0.25	-0.006 / +0.010
4xD	-0.15 / +0.30	-0.006 / +0.012

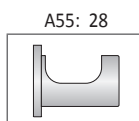
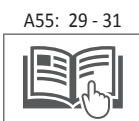
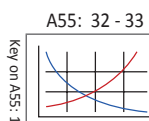

m = Metric (mm)  
i = Imperial (in)

IC inserts sold in quantities of 10  
Insert screws sold in quantities of 10

4TEX Drill Holders | Imperial Shank

11 Series | Diameter Range: 32.00 mm - 38.99 mm (1.260" - 1.535")

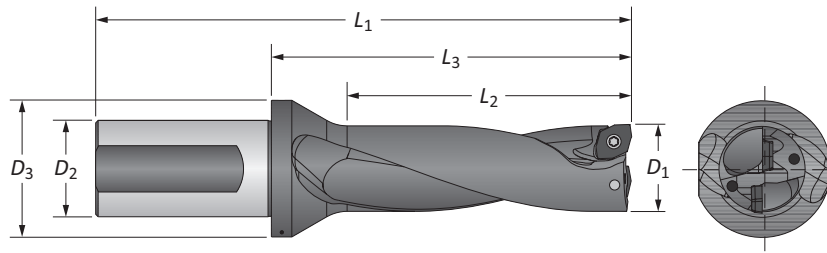

Imperial Shank

Length	D <sub>1</sub>		Body			Shank		Max Offset	Part No.
	mm	in	L <sub>2</sub>	L <sub>3</sub>	L <sub>1</sub>	D <sub>2</sub>	D <sub>3</sub>		
2xD	32.00	1.260	2.520	3.953	6.669	1.500	2.126	0.087	D2113200M-150F
	32.50	1.280	2.559	3.953	6.669	1.500	2.126	0.081	D2113250M-150F
	33.00	1.299	2.598	4.031	6.748	1.500	2.126	0.075	D2113300M-150F
	33.32	1.312	2.624	4.031	6.748	1.500	2.126	0.073	D2111312I-150F
	33.50	1.319	2.638	4.031	6.748	1.500	2.126	0.071	D2113350M-150F
	34.00	1.339	2.677	4.110	6.827	1.500	2.126	0.067	D2113400M-150F
	34.50	1.358	2.717	4.110	6.827	1.500	2.126	0.061	D2113450M-150F
	34.92	1.375	2.750	4.110	6.827	1.500	2.126	0.056	D2111375I-150F
	35.00	1.378	2.756	4.189	6.906	1.500	2.126	0.055	D2113500M-150F
	35.50	1.398	2.795	4.189	6.906	1.500	2.126	0.051	D2113550M-150F
	36.00	1.417	2.835	4.268	6.984	1.500	2.126	0.047	D2113600M-150F
	36.50	1.437	2.874	4.268	6.984	1.500	2.126	0.042	D2113650M-150F
	37.00	1.457	2.913	4.346	7.063	1.500	2.126	0.035	D2113700M-150F
	37.50	1.476	2.953	4.346	7.063	1.500	2.126	0.032	D2113750M-150F
	38.00	1.496	2.992	4.425	7.142	1.500	2.126	0.028	D2113800M-150F
	38.10	1.500	3.000	4.425	7.142	1.500	2.126	0.027	D2111500I-150F
38.50	1.516	3.031	4.425	7.142	1.500	2.126	0.022	D2113850M-150F	
3xD	32.00	1.260	3.780	5.213	7.929	1.500	2.126	0.087	D3113200M-150F
	32.50	1.280	3.839	5.213	7.929	1.500	2.126	0.081	D3113250M-150F
	33.00	1.299	3.898	5.331	8.047	1.500	2.126	0.075	D3113300M-150F
	33.32	1.312	3.936	5.331	8.047	1.500	2.126	0.073	D3111312I-150F
	33.50	1.319	3.957	5.331	8.047	1.500	2.126	0.071	D3113350M-150F
	34.00	1.339	4.016	5.449	8.165	1.500	2.126	0.067	D3113400M-150F
	34.50	1.358	4.075	5.449	8.165	1.500	2.126	0.061	D3113450M-150F
	34.92	1.375	4.125	5.449	8.165	1.500	2.126	0.056	D3111375I-150F
	35.00	1.378	4.134	5.567	8.283	1.500	2.126	0.055	D3113500M-150F
	35.50	1.398	4.193	5.567	8.283	1.500	2.126	0.051	D3113550M-150F
	36.00	1.417	4.252	5.685	8.402	1.500	2.126	0.047	D3113600M-150F
	36.50	1.437	4.311	5.685	8.402	1.500	2.126	0.042	D3113650M-150F
	37.00	1.457	4.370	5.803	8.520	1.500	2.126	0.035	D3113700M-150F
	37.50	1.476	4.429	5.803	8.520	1.500	2.126	0.032	D3113750M-150F
	38.00	1.496	4.488	5.921	8.638	1.500	2.126	0.028	D3113800M-150F
	38.10	1.500	4.500	5.921	8.638	1.500	2.126	0.027	D3111500I-150F
38.50	1.516	4.547	5.921	8.638	1.500	2.126	0.022	D3113850M-150F	

IC Inserts

ISO Material	Part No.	Insert Screw	Torx® Driver	Admissible Tightening Torque
P	4T-11T306-P	7488-T15-1	8T-15	3.5 N-m (30.9 in-lbs)
S	4T-11T306-M			
H	4T-11T306-H			
K	4T-11T306-K			
N	4T-11T306-N			

Expected Hole Tolerances

Length	mm	in
2xD	-0.15 / +0.25	-0.006 / +0.010
3xD	-0.15 / +0.25	-0.006 / +0.010
4xD	-0.15 / +0.30	-0.006 / +0.012

A55: 32 - 33 A55: 29 - 31 A55: 28

Key on A55: 1

m = Metric (mm)  
i = Imperial (in)

IC inserts sold in quantities of 10  
Insert screws sold in quantities of 10

4TEX Drill Holders | Imperial Shank

11 Series | Diameter Range: 32.00 mm - 38.99 mm (1.260" - 1.535")

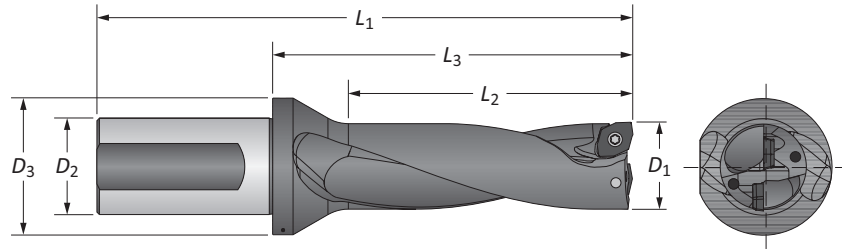

Imperial Shank

Length	D <sub>1</sub>		Body			Shank		Max Offset	Part No.
	mm	in	L <sub>2</sub>	L <sub>3</sub>	L <sub>1</sub>	D <sub>2</sub>	D <sub>3</sub>		
4xD	32.00	1.260	5.039	6.079	8.795	1.500	2.126	0.087	D4113200M-150F
	32.50	1.280	5.118	6.079	8.795	1.500	2.126	0.081	D4113250M-150F
	33.00	1.299	5.197	6.236	8.953	1.500	2.126	0.075	D4113300M-150F
	33.32	1.312	5.248	6.236	8.953	1.500	2.126	0.073	D4111312I-150F
	33.50	1.319	5.276	6.236	8.953	1.500	2.126	0.071	D4113350M-150F
	34.00	1.339	5.354	6.394	9.110	1.500	2.126	0.067	D4113400M-150F
	34.50	1.358	5.433	6.394	9.110	1.500	2.126	0.061	D4113450M-150F
	34.92	1.375	5.500	6.394	9.110	1.500	2.126	0.056	D4111375I-150F
	35.00	1.378	5.512	6.551	9.268	1.500	2.126	0.055	D4113500M-150F
	35.50	1.398	5.591	6.551	9.268	1.500	2.126	0.051	D4113550M-150F
	36.00	1.417	5.669	6.709	9.425	1.500	2.126	0.047	D4113600M-150F
	36.50	1.437	5.748	6.709	9.425	1.500	2.126	0.042	D4113650M-150F
	37.00	1.457	5.827	6.866	9.583	1.500	2.126	0.035	D4113700M-150F
	37.50	1.476	5.906	6.866	9.583	1.500	2.126	0.032	D4113750M-150F
	38.00	1.496	5.984	7.024	9.740	1.500	2.126	0.028	D4113800M-150F
	38.10	1.500	6.000	7.024	9.740	1.500	2.126	0.027	D4111500I-150F
38.50	1.516	6.063	7.024	9.740	1.500	2.126	0.022	D4113850M-150F	

IC Inserts

ISO Material	Part No.	Insert Screw	Torx® Driver	Admissible Tightening Torque
P	4T-11T306-P	7488-T15-1	8T-15	3.5 N-m (30.9 in-lbs)
S	4T-11T306-M			
H	4T-11T306-H			
K	4T-11T306-K			
N	4T-11T306-N			

Expected Hole Tolerances

Length	mm	in
2xD	-0.15 / +0.25	-0.006 / +0.010
3xD	-0.15 / +0.25	-0.006 / +0.010
4xD	-0.15 / +0.30	-0.006 / +0.012

A55: 32 - 33 A55: 29 - 31 A55: 28

Key on A55: 1

m = Metric (mm)  
i = Imperial (in)

IC inserts sold in quantities of 10  
Insert screws sold in quantities of 10

4TEX Drill Holders | Metric Shank

14 Series | Diameter Range: 39.00 mm - 47.00 mm (1.536" - 1.850")

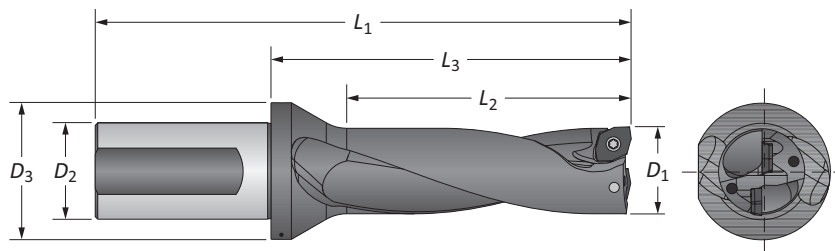

Metric Shank

Length	D <sub>1</sub>		Body			Shank		Max Offset	Part No.
	mm	in	L <sub>2</sub>	L <sub>3</sub>	L <sub>1</sub>	D <sub>2</sub>	D <sub>3</sub>		
2xD	39.00	1.535	78.00	110.40	179.40	40.00	54.00	2.80	D2143900M-40FM
	39.50	1.555	79.00	110.40	179.40	40.00	54.00	2.66	D2143950M-40FM
	39.67	1.562	79.40	110.40	179.40	40.00	54.00	2.61	D2141562I-40FM
	40.00	1.575	80.00	112.40	181.40	40.00	54.00	2.50	D2144000M-40FM
	40.50	1.594	81.00	112.40	181.40	40.00	54.00	2.41	D2144050M-40FM
	41.00	1.614	82.00	114.40	183.40	40.00	54.00	2.30	D2144100M-40FM
	41.28	1.625	82.55	114.40	183.40	40.00	54.00	2.23	D2141625I-40FM
	41.50	1.634	83.00	114.40	183.40	40.00	54.00	2.16	D2144150M-40FM
	42.00	1.654	84.00	116.40	185.40	40.00	54.00	2.00	D2144200M-40FM
	42.50	1.673	85.00	116.40	185.40	40.00	54.00	1.90	D2144250M-40FM
	42.85	1.687	85.70	116.40	185.40	40.00	54.00	1.82	D2141687I-40FM
	43.00	1.693	86.00	118.40	187.40	40.00	59.00	1.80	D2144300M-40FM
	43.50	1.713	87.00	118.40	187.40	40.00	59.00	1.65	D2144350M-40FM
	44.00	1.732	88.00	120.40	189.40	40.00	59.00	1.50	D2144400M-40FM
	44.45	1.750	88.90	120.40	189.40	40.00	59.00	1.41	D2141750I-40FM
	44.50	1.752	89.00	120.40	189.40	40.00	59.00	1.40	D2144450M-40FM
	45.00	1.772	90.00	122.40	191.40	40.00	59.00	1.30	D2144500M-40FM
	45.50	1.791	91.00	122.40	191.40	40.00	59.00	1.15	D2144550M-40FM
	46.02	1.812	92.10	124.40	193.40	40.00	59.00	1.02	D2141812I-40FM
	46.00	1.811	92.00	124.40	193.40	40.00	59.00	1.00	D2144600M-40FM
46.50	1.831	93.00	124.40	193.40	40.00	59.00	0.90	D2144650M-40FM	
47.00	1.850	94.00	126.40	195.40	40.00	59.00	0.80	D2144700M-40FM	
3xD	39.00	1.535	117.00	149.40	218.40	40.00	54.00	2.80	D3143900M-40FM
	39.50	1.555	118.50	149.40	218.40	40.00	54.00	2.66	D3143950M-40FM
	39.67	1.562	119.02	149.40	218.40	40.00	54.00	2.61	D3141562I-40FM
	40.00	1.575	120.00	152.40	221.40	40.00	54.00	2.50	D3144000M-40FM
	40.50	1.594	121.50	152.40	221.40	40.00	54.00	2.41	D3144050M-40FM
	41.00	1.614	123.00	155.40	224.40	40.00	54.00	2.30	D3144100M-40FM
	41.28	1.625	123.83	155.40	224.40	40.00	54.00	2.23	D3141625I-40FM
	41.50	1.634	124.50	155.40	224.40	40.00	54.00	2.16	D3144150M-40FM
	42.00	1.654	126.00	158.40	227.40	40.00	54.00	2.00	D3144200M-40FM
	42.50	1.673	127.50	158.40	227.40	40.00	54.00	1.90	D3144250M-40FM
	42.85	1.687	128.55	158.40	227.40	40.00	54.00	1.82	D3141687I-40FM
	43.00	1.693	129.00	161.40	230.40	40.00	59.00	1.80	D3144300M-40FM

IC Inserts

ISO Material	Part No.	Insert Screw	Torx® Driver	Admissible Tightening Torque
P	4T-140408-P	7595-T20-1	8T-20	4.5 N-m (9.8 in-lbs)
S	4T-140408-M			
H	4T-140408-H			
K	4T-140408-K			
N	4T-140408-N			

Expected Hole Tolerances

Length	mm	in
2xD	-0.20 / +0.30	-0.008 / +0.012
3xD	-0.20 / +0.30	-0.008 / +0.012
4xD	-0.20 / +0.35	-0.008 / +0.014

A55: 32 - 33 A55: 29 - 31 A55: 28

Key on A55: 1

m = Metric (mm)  
i = Imperial (in)

IC inserts sold in quantities of 10  
Insert screws sold in quantities of 10

4TEX Drill Holders | Metric Shank

14 Series | Diameter Range: 39.00 mm - 47.00 mm (1.536" - 1.850")

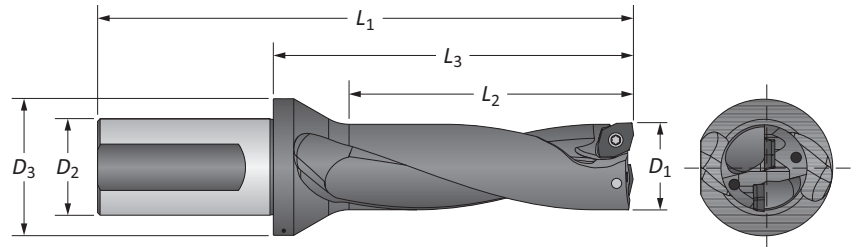

Metric Shank

Length	D <sub>1</sub>		Body			Shank		Max Offset	Part No.
	mm	in	L <sub>2</sub>	L <sub>3</sub>	L <sub>1</sub>	D <sub>2</sub>	D <sub>3</sub>		
3xD	43.50	1.713	130.50	161.40	230.40	40.00	59.00	1.65	D3144350M-40FM
	44.00	1.732	132.00	164.40	233.40	40.00	59.00	1.50	D3144400M-40FM
	44.45	1.750	133.35	164.40	233.40	40.00	59.00	1.41	D3141750I-40FM
	44.50	1.752	133.50	164.40	233.40	40.00	59.00	1.40	D3144450M-40FM
	45.00	1.772	135.00	167.40	236.40	40.00	59.00	1.30	D3144500M-40FM
	45.50	1.791	136.50	167.40	236.40	40.00	59.00	1.15	D3144550M-40FM
	46.00	1.811	138.00	170.40	239.40	40.00	59.00	1.00	D3144600M-40FM
	46.02	1.812	138.07	170.40	239.40	40.00	59.00	1.02	D3141812I-40FM
	46.50	1.831	139.50	170.40	239.40	40.00	59.00	0.90	D3144650M-40FM
47.00	1.850	141.00	173.40	242.40	40.00	59.00	0.80	D3144700M-40FM	
4xD	39.00	1.535	156.00	188.40	257.40	40.00	54.00	2.80	D4143900M-40FM
	39.50	1.555	158.00	188.40	257.40	40.00	54.00	2.66	D4143950M-40FM
	39.67	1.562	158.70	188.40	257.40	40.00	54.00	2.61	D4141562I-40FM
	40.00	1.575	160.00	192.40	261.40	40.00	54.00	2.50	D4144000M-40FM
	40.50	1.594	162.00	192.40	261.40	40.00	54.00	2.41	D4144050M-40FM
	41.00	1.614	164.00	196.40	265.40	40.00	54.00	2.30	D4144100M-40FM
	41.28	1.625	165.10	196.40	265.40	40.00	54.00	2.23	D4141625I-40FM
	41.50	1.634	166.00	196.40	265.40	40.00	54.00	2.16	D4144150M-40FM
	42.00	1.654	168.00	200.40	269.40	40.00	54.00	2.00	D4144200M-40FM
	42.50	1.673	170.00	200.40	269.40	40.00	54.00	1.90	D4144250M-40FM
	42.85	1.687	171.40	200.40	269.40	40.00	54.00	1.82	D4141687I-40FM
	43.00	1.693	172.00	204.40	273.40	40.00	59.00	1.80	D4144300M-40FM
	43.50	1.713	174.00	204.40	273.40	40.00	59.00	1.65	D4144350M-40FM
	44.00	1.732	176.00	208.40	277.40	40.00	59.00	1.50	D4144400M-40FM
	44.45	1.750	177.80	208.40	277.40	40.00	59.00	1.41	D4141750I-40FM
	44.50	1.752	178.00	208.40	277.40	40.00	59.00	1.40	D4144450M-40FM
	45.00	1.772	180.00	212.40	281.40	40.00	59.00	1.30	D4144500M-40FM
	45.50	1.791	182.00	212.40	281.40	40.00	59.00	1.15	D4144550M-40FM
	46.00	1.811	184.00	216.40	285.40	40.00	59.00	1.00	D4144600M-40FM
46.02	1.812	184.10	216.40	285.40	40.00	59.00	1.02	D4141812I-40FM	
46.50	1.831	186.00	216.40	285.40	40.00	59.00	0.90	D4144650M-40FM	
47.00	1.850	188.00	220.40	289.40	40.00	59.00	0.80	D4144700M-40FM	

IC Inserts

ISO Material	Part No.	Insert Screw	Torx® Driver	Admissible Tightening Torque
P	4T-140408-P	7595-T20-1	8T-20	4.5 N-m (9.8 in-lbs)
S	4T-140408-M			
H	4T-140408-H			
K	4T-140408-K			
N	4T-140408-N			

Expected Hole Tolerances

Length	mm	in
2xD	-0.20 / +0.30	-0.008 / +0.012
3xD	-0.20 / +0.30	-0.008 / +0.012
4xD	-0.20 / +0.35	-0.008 / +0.014

Key on A55: 1

A55: 32 - 33

A55: 29 - 31

A55: 28

m = Metric (mm)  
i = Imperial (in)

IC inserts sold in quantities of 10  
Insert screws sold in quantities of 10

4TEX Drill Holders | Imperial Shank

14 Series | Diameter Range: 39.00 mm - 47.00 mm (1.536" - 1.850")

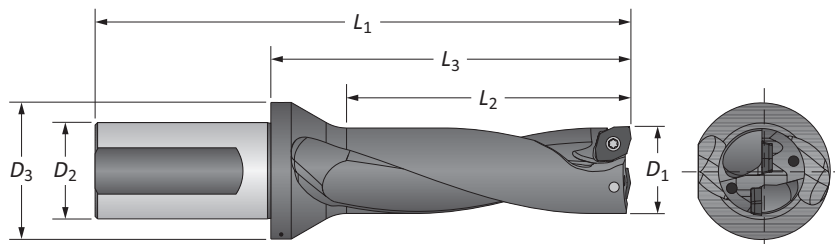

Imperial Shank

Length	D <sub>1</sub>		Body			Shank		Max Offset	Part No.
	mm	in	L <sub>2</sub>	L <sub>3</sub>	L <sub>1</sub>	D <sub>2</sub>	D <sub>3</sub>		
2xD	39.00	1.535	3.071	4.346	7.063	1.500	2.126	0.110	D2143900M-150F
	39.50	1.555	3.110	4.346	7.063	1.500	2.126	0.105	D2143950M-150F
	39.67	1.562	3.124	4.346	7.063	1.500	2.126	0.103	D2141562I-150F
	40.00	1.575	3.150	4.425	7.142	1.500	2.126	0.098	D2144000M-150F
	40.50	1.594	3.189	4.425	7.142	1.500	2.126	0.095	D2144050M-150F
	41.00	1.614	3.228	4.504	7.220	1.500	2.126	0.091	D2144100M-150F
	41.28	1.625	3.250	4.504	7.220	1.500	2.126	0.088	D2141625I-150F
	41.50	1.634	3.268	4.504	7.220	1.500	2.126	0.085	D2144150M-150F
	42.00	1.654	3.307	4.583	7.299	1.500	2.126	0.079	D2144200M-150F
	42.50	1.673	3.346	4.583	7.299	1.500	2.126	0.075	D2144250M-150F
	42.85	1.687	3.374	4.583	7.299	1.500	2.126	0.072	D2141687I-150F
	43.00	1.693	3.386	4.661	7.378	1.500	2.323	0.071	D2144300M-150F
	43.50	1.713	3.425	4.661	7.378	1.500	2.323	0.065	D2144350M-150F
	44.00	1.732	3.465	4.740	7.457	1.500	2.323	0.059	D2144400M-150F
	44.45	1.750	3.500	4.740	7.457	1.500	2.323	0.055	D2141750I-150F
	44.50	1.752	3.504	4.740	7.457	1.500	2.323	0.055	D2144450M-150F
	45.00	1.772	3.543	4.819	7.535	1.500	2.323	0.051	D2144500M-150F
	45.50	1.791	3.583	4.819	7.535	1.500	2.323	0.045	D2144550M-150F
	46.02	1.812	3.624	4.898	7.614	1.500	2.323	0.040	D2141812I-150F
	46.00	1.811	3.622	4.898	7.614	1.500	2.323	0.039	D2144600M-150F
46.50	1.831	3.661	4.898	7.614	1.500	2.323	0.036	D2144650M-150F	
47.00	1.850	3.701	4.976	7.693	1.500	2.323	0.031	D2144700M-150F	
3xD	39.00	1.535	4.606	5.882	8.598	1.500	2.126	0.110	D3143900M-150F
	39.50	1.555	4.665	5.882	8.598	1.500	2.126	0.105	D3143950M-150F
	39.67	1.562	4.686	5.882	8.598	1.500	2.126	0.103	D3141562I-150F
	40.00	1.575	4.724	6.000	8.717	1.500	2.126	0.098	D3144000M-150F
	40.50	1.594	4.783	6.000	8.717	1.500	2.126	0.095	D3144050M-150F
	41.00	1.614	4.843	6.118	8.835	1.500	2.126	0.091	D3144100M-150F
	41.28	1.625	4.875	6.118	8.835	1.500	2.126	0.088	D3141625I-150F
	41.50	1.634	4.902	6.118	8.835	1.500	2.126	0.085	D3144150M-150F
	42.00	1.654	4.961	6.236	8.953	1.500	2.126	0.079	D3144200M-150F
	42.50	1.673	5.020	6.236	8.953	1.500	2.126	0.075	D3144250M-150F
	42.85	1.687	5.061	6.236	8.953	1.500	2.126	0.072	D3141687I-150F
	43.00	1.693	5.079	6.354	9.071	1.500	2.323	0.071	D3144300M-150F

IC Inserts

ISO Material	Part No.	Insert Screw	Torx® Driver	Admissible Tightening Torque
P	4T-140408-P	7595-T20-1	8T-20	4.5 N-m (9.8 in-lbs)
S M	4T-140408-M			
H	4T-140408-H			
K	4T-140408-K			
N	4T-140408-N			

Expected Hole Tolerances

Length	mm	in
2xD	-0.20 / +0.30	-0.008 / +0.012
3xD	-0.20 / +0.30	-0.008 / +0.012
4xD	-0.20 / +0.35	-0.008 / +0.014

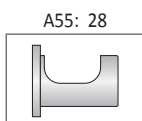
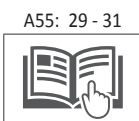
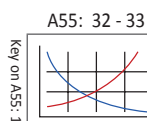

m = Metric (mm)  
i = Imperial (in)

IC inserts sold in quantities of 10  
Insert screws sold in quantities of 10

4TEX Drill Holders | Imperial Shank

14 Series | Diameter Range: 39.00 mm - 47.00 mm (1.536" - 1.850")

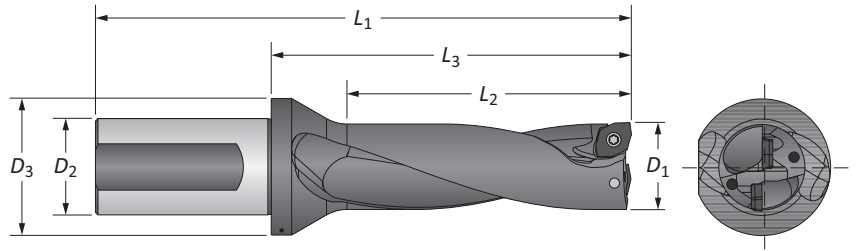

Imperial Shank

Length	D <sub>1</sub>		Body			Shank		Max Offset	Part No.
	mm	in	L <sub>2</sub>	L <sub>3</sub>	L <sub>1</sub>	D <sub>2</sub>	D <sub>3</sub>		
3xD	43.50	1.713	5.138	6.354	9.071	1.500	2.323	0.065	D3144350M-150F
	44.00	1.732	5.197	6.472	9.189	1.500	2.323	0.059	D3144400M-150F
	44.45	1.750	5.250	6.472	9.189	1.500	2.323	0.055	D3141750I-150F
	44.50	1.752	5.256	6.472	9.189	1.500	2.323	0.055	D3144450M-150F
	45.00	1.772	5.315	6.591	6.591	9.307	1.500	2.323	D3144500M-150F
	45.50	1.791	5.374	6.591	6.591	9.307	1.500	2.323	D3144550M-150F
	46.00	1.811	5.433	6.709	6.709	9.425	1.500	2.323	D3144600M-150F
	46.02	1.812	5.436	6.709	6.709	9.425	1.500	2.323	D3141812I-150F
	46.50	1.831	5.492	6.709	6.709	9.425	1.500	2.323	D3144650M-150F
47.00	1.850	5.551	6.827	6.827	9.543	1.500	2.323	D3144700M-150F	
4xD	39.00	1.535	6.142	7.417	10.134	1.500	2.126	0.110	D4143900M-150F
	39.50	1.555	6.220	7.417	10.134	1.500	2.126	0.105	D4143950M-150F
	39.67	1.562	6.248	7.417	10.134	1.500	2.126	0.103	D4141562I-150F
	40.00	1.575	6.299	7.575	10.291	1.500	2.126	0.098	D4144000M-150F
	40.50	1.594	6.378	7.575	10.291	1.500	2.126	0.095	D4144050M-150F
	41.00	1.614	6.457	7.732	10.449	1.500	2.126	0.091	D4144100M-150F
	41.28	1.625	6.500	7.732	10.449	1.500	2.126	0.088	D4141625I-150F
	41.50	1.634	6.535	7.732	10.449	1.500	2.126	0.085	D4144150M-150F
	42.00	1.654	6.614	7.890	10.606	1.500	2.126	0.079	D4144200M-150F
	42.50	1.673	6.693	7.890	10.606	1.500	2.126	0.075	D4144250M-150F
	42.85	1.687	6.748	7.890	10.606	1.500	2.126	0.072	D4141687I-150F
	43.00	1.693	6.772	8.047	10.764	1.500	2.323	0.071	D4144300M-150F
	43.50	1.713	6.850	8.047	10.764	1.500	2.323	0.065	D4144350M-150F
	44.00	1.732	6.929	8.205	10.921	1.500	2.323	0.059	D4144400M-150F
	44.45	1.750	7.000	8.205	10.921	1.500	2.323	0.055	D4141750I-150F
	44.50	1.752	7.008	8.205	10.921	1.500	2.323	0.055	D4144450M-150F
	45.00	1.772	7.087	8.362	11.079	1.500	2.323	0.051	D4144500M-150F
	45.50	1.791	7.165	8.362	11.079	1.500	2.323	0.045	D4144550M-150F
	46.00	1.811	7.244	8.520	11.236	1.500	2.323	0.039	D4144600M-150F
	46.02	1.812	7.248	8.520	11.236	1.500	2.323	0.040	D4141812I-150F
46.50	1.831	7.323	8.520	11.236	1.500	2.323	0.036	D4144700M-150F	
47.00	1.850	7.402	8.677	11.394	1.500	2.323	0.031	D4144650M-150F	

IC Inserts

ISO Material	Part No.	Insert Screw	Torx® Driver	Admissible Tightening Torque
P	4T-140408-P	7595-T20-1	8T-20	4.5 N-m (9.8 in-lbs)
S M	4T-140408-M			
H	4T-140408-H			
K	4T-140408-K			
N	4T-140408-N			

Expected Hole Tolerances

Length	mm	in
2xD	-0.20 / +0.30	-0.008 / +0.012
3xD	-0.20 / +0.30	-0.008 / +0.012
4xD	-0.20 / +0.35	-0.008 / +0.014

A55: 32 - 33      A55: 29 - 31      A55: 28

m = Metric (mm)  
i = Imperial (in)

IC inserts sold in quantities of 10  
Insert screws sold in quantities of 10

## Eccentric Sleeves

For Cutting Diameter / Center Height Adjustment

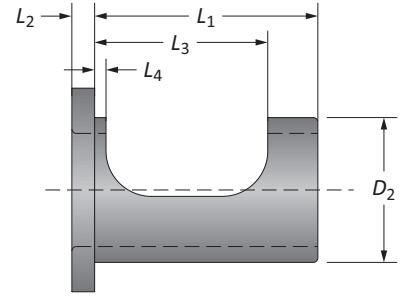
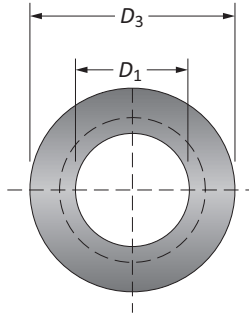

Sleeve Dimensions								Adjustment Range		
	$D_1$	$D_2$	$D_3$	$L_2$	$L_3$	$L_4$	$L_1$	Part No.	Diameter*	Center Height
m	25.00	32.00	49.00	6.00	39.00	2.50	54.00	<b>SLEEVE-25FM</b>	-0.20 to +0.40	-0.15 to +0.20
	32.00	40.00	58.00	6.00	43.00	2.50	59.00	<b>SLEEVE-32FM</b>	-0.20 to +0.40	-0.15 to +0.20
	40.00	50.00	74.00	6.00	49.00	3.00	69.00	<b>SLEEVE-40FM</b>	-0.20 to +0.40	-0.20 to +0.30
i	0.750	1.000	1.614	0.157	1.593	0.118	1.837	<b>SLEEVE-075F</b>	-0.008 to +0.016	-0.006 to +0.008
	1.000	1.250	1.929	0.236	1.593	0.098	1.995	<b>SLEEVE-100F</b>	-0.008 to +0.016	-0.006 to +0.008
	1.250	1.500	2.283	0.236	1.693	0.098	2.087	<b>SLEEVE-125F</b>	-0.008 to +0.016	-0.006 to +0.008
	1.500	2.000	2.913	0.236	1.929	0.118	2.481	<b>SLEEVE-150F</b>	-0.008 to +0.024	-0.008 to +0.012

\*Diameter adjustment range refers to the cutting diameter.

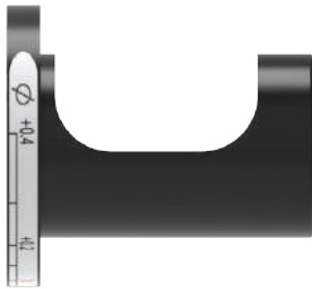

**Milling Applications**  
Peripheral Adjustment Position

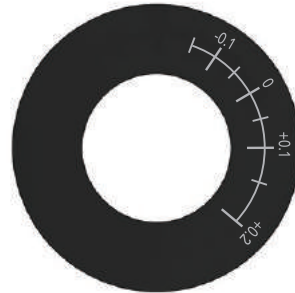

**Lathe Applications**  
Front Adjustment Position

m = Metric (mm)  
i = Imperial (in)



## Diameter Adjustment

### Milling and Lathe Applications

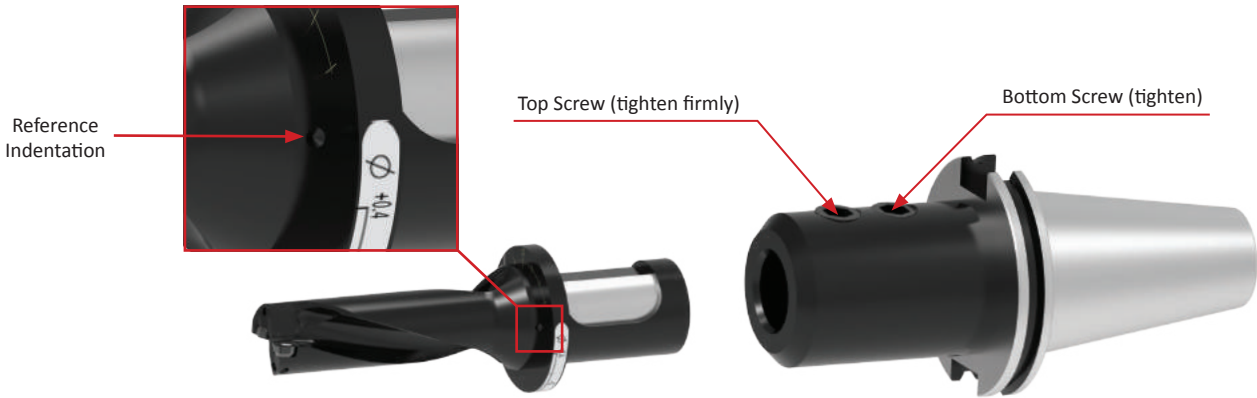

#### For Milling Applications

1. Assemble the 4TEX drill, eccentric sleeve, and tool holder. Do not tighten the tool holder set screws.
2. Using the peripheral marks for milling machines, align the reference indentation on the holder with the 0 (zero) mark on the eccentric sleeve to have no offset.
3. Rotate the sleeve in the (+) or (-) direction to increase or decrease the nominal diameter.
4. Once the drill has arrived at the desired diameter, firmly tighten the top set screw first and then tighten the bottom set screw.

**NOTICE:** Eccentric sleeves are to be used with side-locking tool holders only. Damage may result with other styles of tool holders.

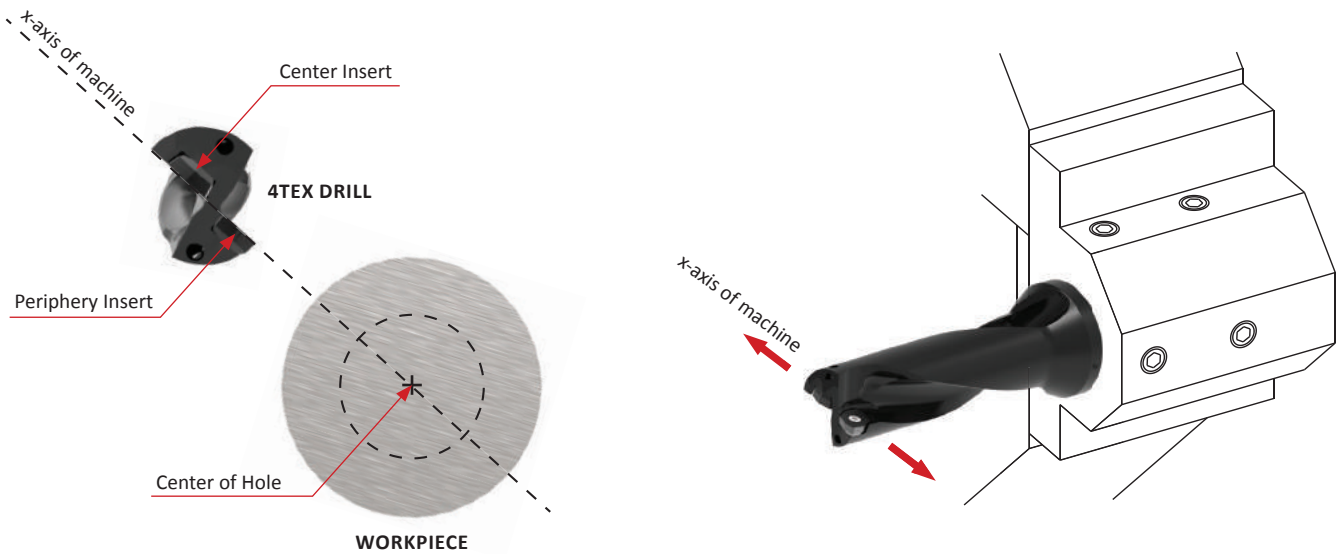

#### For Lathe Applications

1. Assemble the 4TEX drill into the lathe turret with the top face of the inserts parallel to the x-axis of the machine. This will allow for the diameter offsets to be made using the lathe's x-axis.
2. To increase the nominal diameter, offset the x-axis so the periphery insert moves away from the center of the hole.
3. To decrease the nominal diameter, offset the x-axis so the periphery insert moves toward the center of the hole.

**NOTE:** Eccentric sleeve is not required when adjusting the diameter of the hole on a lathe.

## Center Height Alignment

### Proper Center Line Position

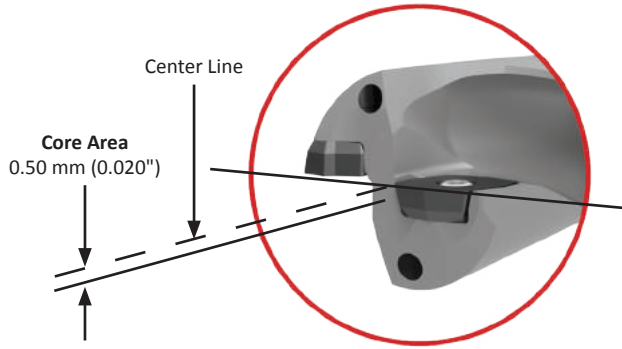
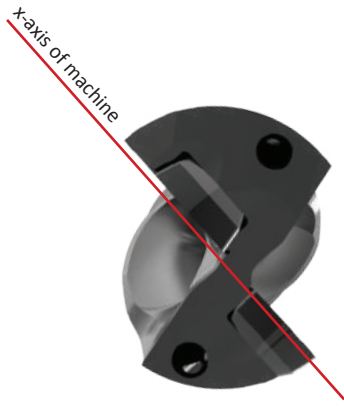

A  
DRILLING  
  
B  
BORING  
  
C  
REAMING  
  
D  
BURNISHING  
  
E  
THREADING  
  
X  
SPECIALS

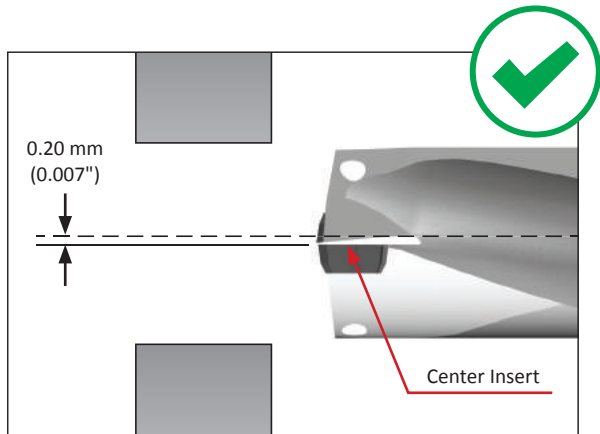

#### Proper Center Height Alignment

- The correct center height alignment will position the center insert 0.2 mm (0.007") below the center line.

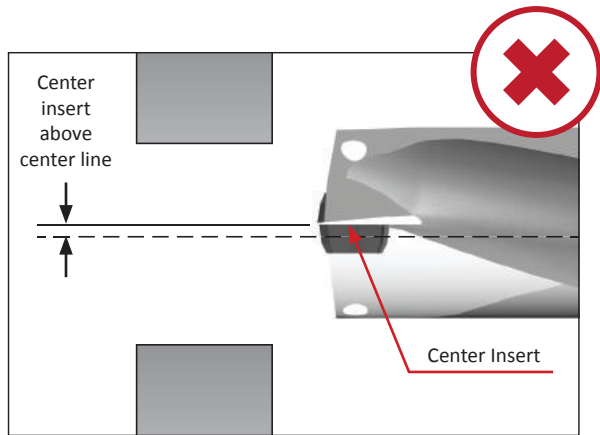
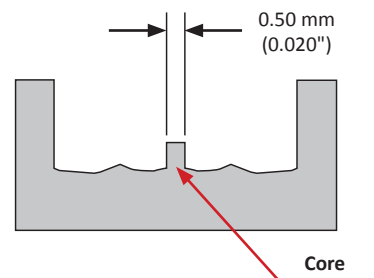

#### Center Insert Above the Center Line

- This will cause fracturing of the center insert
- Requires center height adjustment

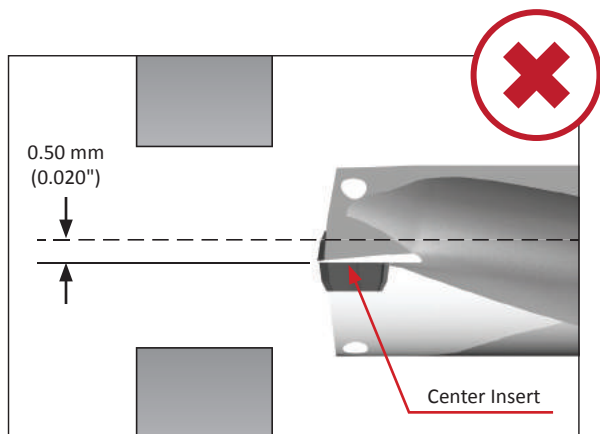
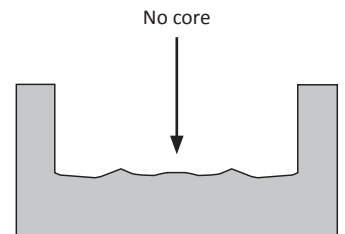

#### Center Insert Too Far Below Center Line

- This will cause the drill to interfere with the drilled hole
- This will impede chip evacuation on the periphery insert
- Requires center height adjustment

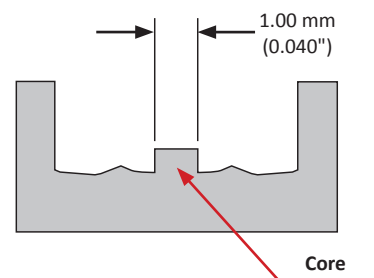

## Center Height Alignment

### How to Correct Issues

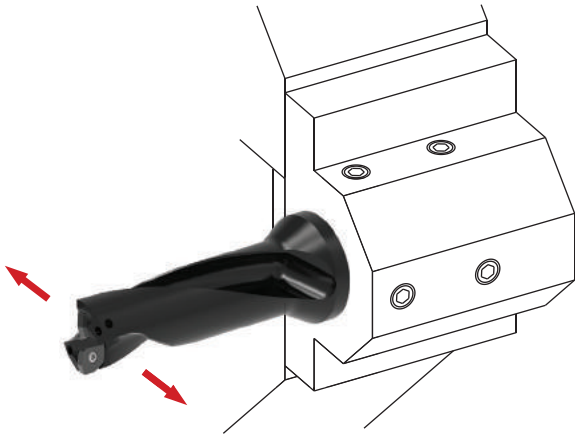

#### Method 1: Adjustment with X-Axis

1. Rotate the drill body so the position of the center line of the inserts is perpendicular to the lathe's x-axis.
2. Use the x-axis to offset the position of the center line in a (+) or (-) direction to increase or decrease the center core diameter at the bottom of the hole.

**NOTE:** This method does not allow diameter adjustments using the x-axis.

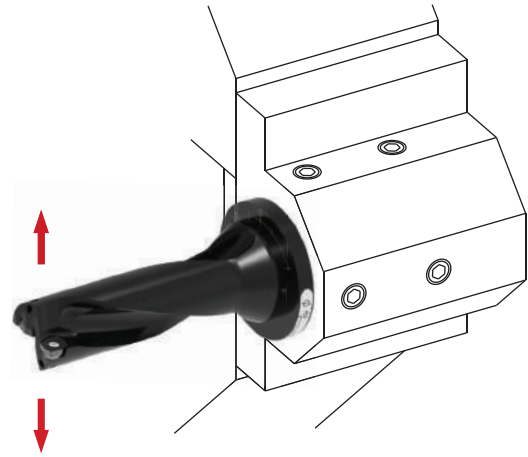

#### Method 2: Adjustment with Eccentric Sleeve

1. Assemble the drill to the turret using the eccentric sleeve, positioning the center line of the inserts parallel to the x-axis.
2. Align the reference indentation on the drill to the "0" setting on the flange face.
3. Rotate the sleeve (+) or (-) to increase or decrease the center height of the inserts in order to increase or decrease the core diameter at the bottom of the hole.

**NOTE:** This method still allows diameter adjustments using the x-axis.

**NOTE (applies to both methods):** Adjusting the center line of the inserts may affect the hole diameter produced. Method two is preferred to make center height adjustments and compensate for hole diameter with the x-axis.

Recommended Drilling Data | Metric (mm)

ISO	Material	Hardness (BHN)	Speed (m/min)			Feed Rate (mm/rev) by Diameter - 2xD, 3xD**					
			P	K	H	M	N	03, 04 Series	05 Series	06, 07 Series	09, 11, 14 Series
			AM480	AM485	TiCN	Ø 12.00 mm - 15.49 mm	Ø 15.50 mm - 18.49 mm	Ø 18.50 mm - 26.49 mm	Ø 26.50 mm - 47.00 mm		
P	Free-Machining Steel 1118, 1215, 12L14, etc.	100 - 150	125 - 365	125 - 365	-	0.07 - 0.1	0.07 - 0.12	0.08 - 0.14	0.08 - 0.14		
		150 - 200	125 - 305	125 - 305	-	0.07 - 0.1	0.07 - 0.12	0.08 - 0.14	0.08 - 0.14		
		200 - 250	125 - 245	125 - 245	-	0.07 - 0.1	0.07 - 0.12	0.08 - 0.14	0.08 - 0.14		
	Low-Carbon Steel 1010, 1020, 1025, 1522, 1144, etc.	85 - 125	125 - 305	125 - 305	-	0.07 - 0.1	0.07 - 0.12	0.08 - 0.14	0.08 - 0.14		
		125 - 175	125 - 305	125 - 305	-	0.07 - 0.1	0.07 - 0.12	0.08 - 0.14	0.08 - 0.14		
		175 - 225	125 - 245	125 - 245	-	0.07 - 0.1	0.07 - 0.12	0.08 - 0.14	0.08 - 0.14		
		225 - 275	125 - 245	125 - 245	-	0.07 - 0.1	0.07 - 0.12	0.08 - 0.14	0.08 - 0.14		
	Medium-Carbon Steel 1030, 1040, 1050, 1527, 1140, 1151, etc.	125 - 175	100 - 245	100 - 245	-	0.05 - 0.14	0.07 - 0.17	0.08 - 0.21	0.08 - 0.21		
		175 - 225	100 - 245	100 - 245	-	0.05 - 0.14	0.07 - 0.17	0.08 - 0.21	0.08 - 0.21		
		225 - 275	100 - 245	100 - 245	-	0.05 - 0.14	0.07 - 0.17	0.08 - 0.21	0.08 - 0.21		
		275 - 325	100 - 245	100 - 185	-	0.05 - 0.14	0.07 - 0.17	0.08 - 0.21	0.08 - 0.21		
	Alloy Steel 4140, 5140, 8640, etc.	125 - 175	100 - 245	-	-	0.05 - 0.14	0.07 - 0.17	0.08 - 0.21	0.08 - 0.21		
		175 - 225	100 - 245	-	-	0.05 - 0.14	0.07 - 0.17	0.08 - 0.21	0.08 - 0.21		
		225 - 275	100 - 245	-	-	0.05 - 0.14	0.07 - 0.17	0.08 - 0.21	0.08 - 0.21		
		275 - 325	100 - 245	-	-	0.05 - 0.14	0.07 - 0.17	0.08 - 0.21	0.08 - 0.21		
		325 - 375	100 - 245	-	-	0.05 - 0.14	0.07 - 0.17	0.08 - 0.21	0.08 - 0.21		
	High-Strength Alloy 4340, 4330V, 300M, etc.	225 - 300	100 - 165	-	-	0.05 - 0.14	0.07 - 0.17	0.08 - 0.21	0.08 - 0.21		
		300 - 350	100 - 185	-	-	0.05 - 0.14	0.07 - 0.17	0.08 - 0.21	0.08 - 0.21		
		350 - 400	100 - 185	-	-	0.05 - 0.14	0.07 - 0.17	0.08 - 0.21	0.08 - 0.21		
	Structural Steel A36, A285, A516, etc.	100 - 150	100 - 185	100 - 185	-	0.05 - 0.13	0.07 - 0.13	0.08 - 0.13	0.08 - 0.13		
		150 - 250	100 - 185	100 - 185	-	0.05 - 0.13	0.07 - 0.13	0.08 - 0.13	0.08 - 0.13		
250 - 350		100 - 185	-	-	0.05 - 0.13	0.07 - 0.13	0.08 - 0.13	0.08 - 0.13			
Tool Steel H-13, H-21, A-4, O-2, S-3, etc.	150 - 200	85 - 185	85 - 185	-	0.05 - 0.08	0.07 - 0.12	0.08 - 0.15	0.08 - 0.15			
	200 - 250	85 - 185	-	-	0.05 - 0.08	0.07 - 0.12	0.08 - 0.15	0.08 - 0.15			
S	High-Temp Alloy* Hastelloy B, Inconel 600, etc.	140 - 220	30 - 80	30 - 80	-	0.06 - 0.08	0.06 - 0.08	0.07 - 0.1	0.07 - 0.1		
		220 - 310	30 - 60	30 - 60	-	0.06 - 0.08	0.06 - 0.08	0.07 - 0.1	0.07 - 0.1		
	Titanium Alloy*	140 - 220	40 - 155	40 - 155	-	0.06 - 0.08	0.06 - 0.08	0.07 - 0.1	0.07 - 0.1		
		220 - 310	40 - 90	40 - 90	-	0.06 - 0.08	0.06 - 0.08	0.07 - 0.1	0.07 - 0.1		
	Aerospace Alloy* S82	185 - 275	30 - 80	30 - 80	-	0.06 - 0.08	0.06 - 0.08	0.07 - 0.1	0.07 - 0.1		
275 - 350		30 - 60	31 - 60	-	0.06 - 0.08	0.06 - 0.08	0.07 - 0.1	0.07 - 0.1			
M	Stainless Steel 400 Series 416, 420, etc.	185 - 275	75 - 185	75 - 215	-	0.05 - 0.1	0.07 - 0.12	0.07 - 0.14	0.07 - 0.14		
		275 - 350	75 - 145	75 - 155	-	0.05 - 0.1	0.07 - 0.12	0.07 - 0.14	0.07 - 0.14		
	Stainless Steel 300 Series 304, 316, 17-4PH, etc.	135 - 185	75 - 185	75 - 215	-	0.05 - 0.1	0.07 - 0.12	0.07 - 0.14	0.07 - 0.14		
		185 - 275	75 - 145	75 - 155	-	0.05 - 0.1	0.07 - 0.12	0.07 - 0.14	0.07 - 0.14		
	Super Duplex Stainless Steel	135 - 185	75 - 185	75 - 215	-	0.05 - 0.1	0.07 - 0.12	0.07 - 0.14	0.07 - 0.14		
185 - 275		75 - 145	75 - 155	-	0.05 - 0.1	0.07 - 0.12	0.07 - 0.14	0.07 - 0.14			
H	Wear Plate Hardox, AR400, T-1, etc.	400	30 - 60	-	-	0.05 - 0.08	0.07 - 0.12	0.08 - 0.15	0.08 - 0.15		
		500	30 - 60	-	-	0.05 - 0.08	0.07 - 0.12	0.08 - 0.15	0.08 - 0.15		
		600	30 - 60	-	-	0.05 - 0.08	0.07 - 0.12	0.08 - 0.15	0.08 - 0.15		
	Hardened Steel	300 - 400	30 - 90	-	-	0.05 - 0.08	0.07 - 0.12	0.08 - 0.15	0.08 - 0.15		
400 - 500		30 - 60	-	-	0.05 - 0.08	0.07 - 0.12	0.08 - 0.15	0.08 - 0.15			
K	Nodular, Grey, Ductile Cast Iron	120 - 150	90 - 245	-	-	0.08 - 0.14	0.08 - 0.19	0.08 - 0.21	0.08 - 0.21		
		150 - 200	90 - 245	-	-	0.08 - 0.14	0.08 - 0.19	0.08 - 0.21	0.08 - 0.21		
		200 - 220	90 - 155	-	-	0.08 - 0.14	0.08 - 0.19	0.08 - 0.21	0.08 - 0.21		
		220 - 260	80 - 125	-	-	0.08 - 0.14	0.08 - 0.19	0.08 - 0.21	0.08 - 0.21		
		260 - 320	80 - 125	-	-	0.08 - 0.14	0.08 - 0.19	0.08 - 0.21	0.08 - 0.21		
N	Cast Aluminium	30	-	-	245 - 610	0.07 - 0.12	0.08 - 0.14	0.08 - 0.17	0.08 - 0.21		
		180	-	-	245 - 610	0.07 - 0.12	0.08 - 0.14	0.08 - 0.17	0.08 - 0.21		
	Wrought Aluminium	30	-	-	245 - 610	0.07 - 0.12	0.08 - 0.14	0.08 - 0.17	0.08 - 0.21		
		180	-	-	245 - 610	0.07 - 0.12	0.08 - 0.14	0.08 - 0.17	0.08 - 0.21		
	Aluminium Bronze	100 - 200	150 - 305	-	150 - 305	0.07 - 0.12	0.08 - 0.14	0.08 - 0.17	0.08 - 0.21		
		200 - 250	150 - 305	-	150 - 305	0.07 - 0.12	0.08 - 0.14	0.08 - 0.17	0.08 - 0.21		
	Brass	100	150 - 305	-	150 - 305	0.07 - 0.12	0.08 - 0.14	0.08 - 0.17	0.08 - 0.21		
Copper	60	-	-	150 - 305	0.07 - 0.12	0.08 - 0.14	0.08 - 0.17	0.08 - 0.21			

\*For high-temp materials, 70 BAR is recommended as well as a quality synthetic coolant at approximately 10% emulsion.

\*\*For 4xD tools, begin at low end of feed recommendation.

**IMPORTANT:** The speeds and feeds listed above are a general starting point for all applications. Factory technical assistance is also available through our Application Engineering Team.  
email: [engineering.eu@alliedmachine.com](mailto:engineering.eu@alliedmachine.com)

**Recommended Drilling Data | Imperial (inch)**

ISO	Material	Hardness (BHN)	Speed (SFM)			Feed Rate (IPR) by Diameter - 2xD, 3xD**					
			P	K	H	M	N	03, 04 Series	05 Series	06, 07 Series	09, 11, 14 Series
			AM480	AM485	TiCN	Ø 0.472" - 0.610"	Ø 0.611" - 0.728"	Ø 0.728" - 1.043"	Ø 1.044" - 1.850"		
P	Free-Machining Steel 1118, 1215, 12L14, etc.	100-150	400 - 1200	400 - 1200	-	0.0025 - 0.004	0.0025 - 0.005	0.003 - 0.0055	0.003 - 0.0055		
		150-200	400 - 1000	400 - 1000	-	0.0025 - 0.004	0.0025 - 0.005	0.003 - 0.0055	0.003 - 0.0055		
		200-250	400 - 800	400 - 800	-	0.0025 - 0.004	0.0025 - 0.005	0.003 - 0.0055	0.003 - 0.0055		
	Low-Carbon Steel 1010, 1020, 1025, 1522, 1144, etc.	85-125	400 - 1000	400 - 1000	-	0.0025 - 0.004	0.0025 - 0.005	0.003 - 0.0055	0.003 - 0.0055		
		125-175	400 - 1000	400 - 1000	-	0.0025 - 0.004	0.0025 - 0.005	0.003 - 0.0055	0.003 - 0.0055		
		175-225	400 - 800	400 - 800	-	0.0025 - 0.004	0.0025 - 0.005	0.003 - 0.0055	0.003 - 0.0055		
	Medium-Carbon Steel 1030, 1040, 1050, 1527, 1140, 1151, etc.	225-275	400 - 800	400 - 800	-	0.0025 - 0.004	0.0025 - 0.005	0.003 - 0.0055	0.003 - 0.0055		
		125-175	330 - 800	330 - 800	-	0.0015 - 0.0055	0.0025 - 0.0065	0.003 - 0.008	0.003 - 0.008		
		175-225	330 - 800	330 - 800	-	0.0015 - 0.0055	0.0025 - 0.0065	0.003 - 0.008	0.003 - 0.008		
	Alloy Steel 4140, 5140, 8640, etc.	225-275	330 - 800	330 - 800	-	0.0015 - 0.0055	0.0025 - 0.0065	0.003 - 0.008	0.003 - 0.008		
		275-325	330 - 600	330 - 600	-	0.0015 - 0.0055	0.0025 - 0.0065	0.003 - 0.008	0.003 - 0.008		
		125-175	330 - 800	-	-	0.0015 - 0.0055	0.0025 - 0.0065	0.003 - 0.008	0.003 - 0.008		
	High-Strength Alloy 4340, 4330V, 300M, etc.	175-225	330 - 800	-	-	0.0015 - 0.0055	0.0025 - 0.0065	0.003 - 0.008	0.003 - 0.008		
		225-275	330 - 800	-	-	0.0015 - 0.0055	0.0025 - 0.0065	0.003 - 0.008	0.003 - 0.008		
		275-325	330 - 800	-	-	0.0015 - 0.0055	0.0025 - 0.0065	0.003 - 0.008	0.003 - 0.008		
Structural Steel A36, A285, A516, etc.	325-375	330 - 800	-	-	0.0015 - 0.0055	0.0025 - 0.0065	0.003 - 0.008	0.003 - 0.008			
	100-150	330 - 600	330 - 600	-	0.0015 - 0.0055	0.0025 - 0.0065	0.003 - 0.008	0.003 - 0.008			
	150-250	330 - 600	330 - 600	-	0.0015 - 0.0055	0.0025 - 0.0065	0.003 - 0.008	0.003 - 0.008			
Tool Steel H-13, H-21, A-4, O-2, S-3, etc.	250-350	330 - 600	-	-	0.0015 - 0.0055	0.0025 - 0.0065	0.003 - 0.008	0.003 - 0.008			
	150-200	270 - 600	270 - 600	-	0.0015 - 0.003	0.0025 - 0.005	0.003 - 0.006	0.003 - 0.006			
S	High-Temp Alloy* Hastelloy B, Inconel 600, etc.	200-250	270 - 600	-	-	0.0015 - 0.003	0.0025 - 0.005	0.003 - 0.006	0.003 - 0.006		
		140 - 220	100 - 250	100 - 250	-	0.002 - 0.003	0.002 - 0.003	0.0025 - 0.004	0.0025 - 0.004		
S	Titanium Alloy*	220 - 310	100 - 200	100 - 200	-	0.002 - 0.003	0.002 - 0.003	0.0025 - 0.004	0.0025 - 0.004		
		140 - 220	140 - 500	140 - 500	-	0.002 - 0.003	0.002 - 0.003	0.0025 - 0.004	0.0025 - 0.004		
S	Aerospace Alloy* S82	220 - 310	140 - 300	140 - 300	-	0.002 - 0.003	0.002 - 0.003	0.0025 - 0.004	0.0025 - 0.004		
		185 - 275	100 - 250	100 - 250	-	0.002 - 0.003	0.002 - 0.003	0.0025 - 0.004	0.0025 - 0.004		
M	Stainless Steel 400 Series 416, 420, etc.	275 - 350	100 - 200	100 - 200	-	0.002 - 0.003	0.002 - 0.003	0.0025 - 0.004	0.0025 - 0.004		
		185 - 275	240 - 600	240 - 700	-	0.0015 - 0.004	0.0025 - 0.005	0.0025 - 0.0055	0.0025 - 0.0055		
M	Stainless Steel 300 Series 304, 316, 17-4PH, etc.	275 - 350	240 - 470	240 - 500	-	0.0015 - 0.004	0.0025 - 0.005	0.0025 - 0.0055	0.0025 - 0.0055		
		135 - 185	240 - 600	240 - 700	-	0.0015 - 0.004	0.0025 - 0.005	0.0025 - 0.0055	0.0025 - 0.0055		
M	Super Duplex Stainless Steel	185 - 275	240 - 470	240 - 500	-	0.0015 - 0.004	0.0025 - 0.005	0.0025 - 0.0055	0.0025 - 0.0055		
		135 - 185	240 - 600	240 - 700	-	0.0015 - 0.004	0.0025 - 0.005	0.0025 - 0.0055	0.0025 - 0.0055		
H	Wear Plate Hardox, AR400, T-1, etc.	400	100 - 200	-	-	0.0015 - 0.003	0.0025 - 0.005	0.003 - 0.006	0.003 - 0.006		
		500	100 - 200	-	-	0.0015 - 0.003	0.0025 - 0.005	0.003 - 0.006	0.003 - 0.006		
		600	100 - 200	-	-	0.0015 - 0.003	0.0025 - 0.005	0.003 - 0.006	0.003 - 0.006		
	Hardened Steel	300 - 400	100 - 300	-	-	0.0015 - 0.003	0.0025 - 0.005	0.003 - 0.006	0.003 - 0.006		
400 - 500		100 - 200	-	-	0.0015 - 0.003	0.0025 - 0.005	0.003 - 0.006	0.003 - 0.006			
K	Nodular, Grey, Ductile Cast Iron	120 - 150	300 - 800	-	-	0.003 - 0.0055	0.003 - 0.007	0.003 - 0.008	0.003 - 0.008		
		150 - 200	300 - 800	-	-	0.003 - 0.0055	0.003 - 0.007	0.003 - 0.008	0.003 - 0.008		
		200 - 220	300 - 500	-	-	0.003 - 0.0055	0.003 - 0.007	0.003 - 0.008	0.003 - 0.008		
		220 - 260	270 - 400	-	-	0.003 - 0.0055	0.003 - 0.007	0.003 - 0.008	0.003 - 0.008		
		260 - 320	270 - 400	-	-	0.003 - 0.0055	0.003 - 0.007	0.003 - 0.008	0.003 - 0.008		
N	Cast Aluminium	30	-	-	800 - 2000	0.0025 - 0.005	0.003 - 0.0055	0.003 - 0.0065	0.003 - 0.008		
		180	-	-	800 - 2000	0.0025 - 1.005	0.003 - 0.0055	0.003 - 0.0065	0.003 - 0.008		
	Wrought Aluminium	30	-	-	800 - 2000	0.0025 - 0.005	0.003 - 0.0055	0.003 - 0.0065	0.003 - 0.008		
		180	-	-	800 - 2000	0.0025 - 0.005	0.003 - 0.0055	0.003 - 0.0065	0.003 - 0.008		
	Aluminium Bronze	100 - 200	500 - 1000	-	500 - 1000	0.0025 - 0.005	0.003 - 0.0055	0.003 - 0.0065	0.003 - 0.008		
		200 - 250	500 - 1000	-	500 - 1000	0.0025 - 0.005	0.003 - 0.0055	0.003 - 0.0065	0.003 - 0.008		
Brass	100	500 - 1000	-	500 - 1000	0.0025 - 0.005	0.003 - 0.0055	0.003 - 0.0065	0.003 - 0.008			
Copper	60	-	-	500 - 1000	0.0025 - 0.005	0.003 - 0.0055	0.003 - 0.0065	0.003 - 0.008			

\*For high-temp materials, 1000 PSI is recommended as well as a quality synthetic coolant at approximately 10% emulsion.

\*\*For 4xD tools, begin at low end of feed recommendation.

**IMPORTANT:** The speeds and feeds listed above are a general starting point for all applications. Factory technical assistance is also available through our Application Engineering Team.  
email: [engineering.eu@alliedmachine.com](mailto:engineering.eu@alliedmachine.com)

A  
DRILLING  
B  
BORING  
C  
REAMING  
D  
BURNISHING  
E  
THREADING  
X  
SPECIALS



### Insert Geometry Recommendations

A DRILLING	ISO	Material	Hardness (BHN)	Geometry				
				P	M	K	N	H
B BORING	P	Free-Machining Steel 1118, 1215, 12L14, etc.	100 - 150	○	●			
			150 - 200	●	○			
			200 - 250	●	○			
	P	Low-Carbon Steel 1010, 1020, 1025, 1522, 1144, etc.	85 - 125	○	●			
			125 - 175	○	●			
			175 - 225	○	●			
	P	Medium-Carbon Steel 1030, 1040, 1050, 1527, 1140, 1151, etc.	225 - 275	●	○			
			125 - 175	○	●			
			175 - 225	○	●			
	P	Alloy Steel 4140, 5140, 8640, etc.	225 - 275	●	○			
			275 - 325	●	○			○
			125 - 175	○	●			
	P	High-Strength Alloy 4340, 4330V, 300M, etc.	175 - 225	●	○			
			225 - 275	●	○			○
			275 - 325	●	○			○
	P	Structural Steel A36, A285, A516, etc.	325 - 375	○	○			●
			225 - 300	●	○			
			300 - 350	○	○			●
P	High-Strength Alloy 4340, 4330V, 300M, etc.	350 - 400	○	○			●	
		100 - 150	○	○	●			
		150 - 250	○	○	●			
P	Structural Steel A36, A285, A516, etc.	250 - 350	●	○			○	
		150 - 200	●	○				
		200 - 250	●	○			○	
P	Tool Steel H-13, H-21, A-4, O-2, S-3, etc.	150 - 200	●	○				
		200 - 250	●	○			○	
		140 - 220	○	○	●			
S	High-Temp Alloy* Hastelloy B, Inconel 600, etc.	220 - 310	○	○	●			
		140 - 220	○	○	●			
		220 - 310	○	○	●			
S	Titanium Alloy*	185 - 275	○	○	●			
		275 - 350	○	○	●			
		185 - 275	○	○	●			
S	Aerospace Alloy* S82	275 - 350	○	○	●			
		185 - 275	○	○	●			
		275 - 350	○	○	●			
M	Stainless Steel 400 Series 416, 420, etc.	185 - 275	○	○	●			
		275 - 350	○	○	●			
		135 - 185	○	○	●			
M	Stainless Steel 300 Series 304, 316, 17-4PH, etc.	185 - 275	○	○	●			
		135 - 185	○	○	●			
		185 - 275	○	○	●			
M	Super Duplex Stainless Steel	135 - 275	○	○	●			
		400	○	○			●	
		500	○	○			●	
H	Wear Plate Hardox, AR400, T-1, etc.	600	○	○			●	
		300 - 400	○	○			●	
		400 - 500	○	○			●	
H	Hardened Steel	120 - 150	●	○				
		150 - 200	●	○				
		200 - 220	●	○				
K	Nodular, Ductile Cast Iron	220 - 260			●		○	
		260 - 320			●		○	
		120 - 150			●		○	
K	Grey / White Iron	150 - 200			●		○	
		200 - 220			●		○	
		220 - 260			●		○	
K	Grey / White Iron	260 - 320			●		○	
		30				●		
		180				●		
N	Cast Aluminium	30				●		
		180				●		
		30				●		
N	Wrought Aluminium	180				●		
		100 - 200	○			●		
		200 - 250	○			●		
N	Aluminium Bronze	100 - 200	○			●		
		200 - 250	○			●		
N	Brass	100	○			●		
		60	○			●		
N	Copper	60	○			●		

A  
DRILLING

B  
BORING



C  
REAMING

D  
URNISHING

E  
HREADING

X  
PECIALS

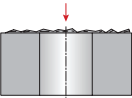
## Troubleshooting

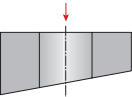
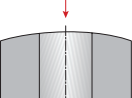
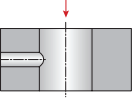
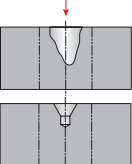
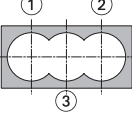
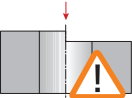
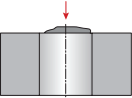
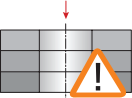
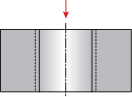
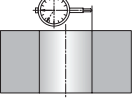
1.		<p><b>Starting on Uneven Surfaces</b></p> <ul style="list-style-type: none"> <li>• Reduce entry feed by 50% if necessary</li> </ul>
2.		<p><b>Starting on Angled Surfaces</b></p> <ul style="list-style-type: none"> <li>• Reduce entry feed by 20 - 50%</li> <li>• Use lower rake geometry if insert chipping occurs</li> </ul>
3.		<p><b>Angled Bore Exit</b></p> <ul style="list-style-type: none"> <li>• Reduce entry feed by 50% on breakout</li> <li>• Use tough insert and stable corner radius</li> </ul>
4.		<p><b>Starting on Convex Surfaces</b></p> <ul style="list-style-type: none"> <li>• Reduce entry feed by 50%</li> <li>• Use lower rake geometry if insert chipping occurs</li> </ul>
5.		<p><b>Drilling Through a Cross Hole</b></p> <ul style="list-style-type: none"> <li>• Reduce feed rate 50% if necessary</li> <li>• Use good coolant flow and monitor chip packing</li> <li>• Use lower rake geometry if insert chipping occurs</li> </ul>
6.		<p><b>Drilling on a Groove or Large Centering Box</b></p> <ul style="list-style-type: none"> <li>• Reduce entry feed</li> <li>• Use lower rake geometry for center insert</li> </ul>
7.		<p><b>Chain Drilling</b></p> <ul style="list-style-type: none"> <li>• Use good coolant flow</li> <li>• Reduce feed rate by 50% for interrupted cut</li> <li>• Use lower rake geometry if insert chipping occurs</li> </ul>
8.		<p><b>Starting on an Edge</b></p> <ul style="list-style-type: none"> <li>• Reduce entry feed rate by 50%</li> <li>• Use lower rake geometry if insert chipping occurs</li> </ul>
9.		<p><b>Starting on a Welded Seam</b></p> <ul style="list-style-type: none"> <li>• Reduce entry feed rate by 50%</li> <li>• Use lower rake geometry if insert chipping occurs</li> </ul>
10.		<p><b>Drilling Through Stacked Plates</b></p> <ul style="list-style-type: none"> <li>• Not recommended</li> </ul>
11.		<p><b>Opening an Existing Hole</b></p> <ul style="list-style-type: none"> <li>• Use flood coolant</li> </ul>
12.		<p><b>Adjustable</b></p> <ul style="list-style-type: none"> <li>• For mills, use eccentric sleeve with end mill holder</li> <li>• For lathes, use x-axis to adjust offset <math>\varnothing</math></li> </ul> <p>NOTE: Refer to maximum offset <math>\varnothing</math> in data tables</p>

## Safety Information



### Mechanical / Physical Hazards

Operating cutting tools may present both mechanical and physical hazards. These hazards can result in serious injury to workers or those near machines and damage to machines and the cutting tools. Cutting tools and/or assemblies may break or come loose when in operation causing projectile metal fragments. Metal chips produced by cutting tools have sharp edges and may be very hot. To minimise the risk of mechanical or physical hazards:

- Always secure all components of the cutting tool assembly before operating.
- Wear cut-resistant gloves when handling cutting tool components and assemblies.
- Do not touch metal chips produced by the cutting tools with your hands.
- Always wear appropriate personal protective equipment including safety goggles or glasses with side shields.
- Immediately discontinue use of damaged cutting tools.
- To avoid machine tool damage, make sure the machine has adequate power and torque for the cutting tool when operating. See catalogue for power and torque requirements.
- Operating long cutting tools at high spindle speeds can result in a high risk of tool failure and serious injury. Visit [www.alliedmachine.com/DeepHoleGuidelines](http://www.alliedmachine.com/DeepHoleGuidelines) to read guidelines specific for deep hole drilling.

### Dust and Fume Hazards

Grinding, welding, cutting or burning hard metals such as high-speed steel, cobalt or carbides produces hazardous dust and/or fumes. Continued long-term exposure to hazardous dust and fumes can cause serious health issues. To minimise the risk of dust and fume hazards:

- Do not regrind or sharpen cutting tools without using adequate ventilation.
- Use appropriate personal protective equipment such as approved respirator to avoid inhalation, swallowing, or skin contact with the hazardous dust and/or fumes.
- Do not eat, drink, or smoke in the machine operation area. Always wash skin prior to eating, drinking, or smoking to avoid hazardous ingestion.

### Sensitizing Hazards

Components of an assembled cutting tool are made from a variety of metal elements that may cause allergic skin reactions with prolonged skin contact. To minimise the risk of allergic skin reactions:

- Avoid skin contact with cutting tools.
- Wear appropriate gloves and protective clothing.
- Wash skin and launder clothing after handling cutting tools to reduce the risk of skin allergies.

### Preventive Safety Measure Applicable to all Hazards

- Prior to using cutting tools, always read Allied Machine's Safety Data Sheets, product catalogue, and product labels for additional warnings for the Allied Machine product being used.
- For machining safety, only operate equipment when all necessary guards, interlocks and other safety devices are in place and functional. Use all appropriate safety guards or machine encapsulations to securely collect particles such as chips or cutting elements that may become projectiles.

#### Through Hole

- With through holes, a **sharp-edged disc** is created as tool breakout occurs.
  - ▲ Proper personal protective equipment must be used to prevent injury (e.g. wear cut-resistant gloves).









## Warranty Information



Allied Machine & Engineering ("Allied Machine") warrants to original equipment manufacturers, distributors, industrial and commercial users of its products for one year from the original date of sale that each new product manufactured or supplied by Allied Machine shall be free from defects in material and workmanship.

Allied Machine's sole and exclusive obligation under this warranty is limited to, at its option, without additional charge, replacing or repairing this product or issuing a credit. For this warranty to be applied, the product must be returned freight prepaid to the plant designated by an Allied Machine representative and which, upon inspection, is determined by Allied Machine to be defective in material and workmanship.

Complete information as to operating conditions, machine, setup, and the application of cutting fluid should accompany any product returned for inspection. This warranty shall not apply to any Allied Machine products which have been subjected to misuse, abuse, improper operating conditions, improper machine setup or improper application of cutting fluid or which have been repaired or altered if such repair or alteration, in the judgement of Allied Machine, would adversely affect the performance of the product.

**THIS WARRANTY IS IN LIEU OF ALL OTHER WARRANTIES, EXPRESS OR IMPLIED, INCLUDING ANY IMPLIED WARRANTY OF MERCHANTABILITY OR FITNESS FOR A PARTICULAR PURPOSE.** Allied Machine shall have no liability or responsibility for any claim, whether in contract, tort or otherwise, for any loss or damage arising out of, connected with, or resulting from the manufacture, sale, delivery or use of any product sold hereunder, in excess of the cost of replacement or repair as provided herein.

Allied Machine shall not be liable in contract or in tort (including, without limitation, negligence, strict liability or otherwise) for economic losses of any kind or for any special, incidental, indirect, consequential, punitive or exemplary damages arising in any way out of the performance of, or failure to perform this agreement.

**ALL PRICES, DELIVERIES, DESIGNS, AND MATERIALS ARE SUBJECT TO CHANGE WITHOUT NOTICE.**



Allied Machine & Engineering Co. Europe Ltd. is registered to ISO 9001:2015 by bsi.



Allied Machine & Engineering is registered to ISO 9001:2015 by DQS



Wohlhaupter GmbH is registered to ISO 9001:2015 by QA TECHNIC

## Europe

### Allied Machine & Engineering Co. (Europe) Ltd.

93 Vantage Point  
Pensnett Estate  
Kingswinford  
West Midlands  
DY6 7FR England

**Phone:**

+44 (0) 1384.400900

### Wohlhaupter GmbH

Maybachstrasse 4  
Postfach 1264  
72636 Frickenhausen  
Germany

**Phone:**

+49 (0) 7022.408.0

**Fax:**

+49 (0) 7022.408.212

## United States

### Allied Machine & Engineering

120 Deeds Drive  
Dover OH 44622  
United States

**Phone:**

+1.330.343.4283

**Fax:**

+1.330.602.3400

**Toll Free USA and Canada:**

800.321.5537

**Toll Free USA and Canada:**

800.223.5140

### Allied Machine & Engineering

485 W Third Street  
Dover OH 44622  
United States

**Phone:**

+1.330.343.4283

**Fax:**

+1.330.364.7666  
(Engineering Dept.)

**Toll Free USA and Canada:**

800.321.5537

## Asia

### Wohlhaupter India Pvt. Ltd.

B-23, 3rd Floor  
B Block Community Centre  
Janakpuri, New Delhi - 110058  
India

**Phone:**

+91 (0) 11.41827044

Your local Allied Machine representative:

[www.alliedmachine.com](http://www.alliedmachine.com)

Allied Machine & Engineering Co. (Europe) Ltd is registered to **ISO 9001:2015** by bsi.

Allied Machine & Engineering is registered to **ISO 9001:2015** by DQS

Wohlhaupter GmbH is registered to **ISO 9001:2015** by QTA TECHNIC

