



**ALLIED MACHINE
& ENGINEERING**

WOHLHAUPTER®

Holemaking Solutions for Today's Manufacturing



Boring



Reaming



Burnishing



Threading



Specials



APX™ Drill

▶ **DRILLING**

Deep Hole / Large Diameter Drilling System

SECTION

A50

APX™ Drill

APX™ Drill

Deep Hole / Large Diameter Drilling System

► **Diameter Range:** 33.00 mm - 101.60 mm (1.299" - 4.000")



Don't Let Your Machine Slow You Down

The APX deep hole/large diameter drilling system delivers the strength and versatility needed for any deep hole drilling application. The breakthrough geometry is designed to increase penetration rates and tool life. By allowing for higher spindle speeds, the APX lets you take advantage of the power curve on modern CNC machines.

Excellent chip control	Improves hole quality and surface finish	Provides maximum durability and stability
------------------------	--	---

Applicable Industries



Aerospace



Agriculture



Automotive



Firearms



General Machining



Oil & Gas



Renewable Energy

Your safety and the safety of others is very important. This catalogue contains important safety messages. Always read and follow all safety precautions.



This triangle is a safety hazard symbol. It alerts you to potential safety hazards that can cause tool failure and serious injury.

When you see this symbol in the catalogue, look for a related safety message that may be near this triangle or referred to in the nearby text.

There are safety signal words also used in the catalogue. Safety messages follow these words.

WARNING

WARNING (shown above) means that failure to follow the precautions in this message could result in tool failure and serious injury.

NOTICE means that failure to follow the precautions in this message could result in damage to the tool or machine but not result in personal injury.

NOTE and **IMPORTANT** are also used. These are important that you read and follow but are not safety-related.

Visit www.alliedmachine.com for the most up-to-date information and procedures.

Reference Icons

The following icons will appear throughout the catalogue to help you navigate between products.



Setup / Assembly Information

Detailed instructions and information regarding the corresponding part(s)

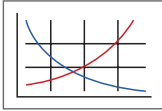

Recommended Cutting Data

Speed and feed recommendations for optimum and safe drilling

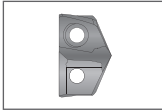

GEN3SYS® Pilot Inserts

Lists the GEN3SYS XT Pro pilot ISO insert options for each APX drill series

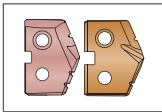

T-A® Pilot Inserts

Lists the T-A and GEN2 T-A pilot insert options for each APX Drill series



Through Coolant Option

Indicates that the product is through coolant

Series	Diameter Range	
	Metric (mm)	Imperial (inch)
33	33.00 - 37.99	1.299 - 1.496
38	38.00 - 43.99	1.496 - 1.732
44	44.00 - 50.99	1.732 - 2.008
51	51.00 - 56.99	2.008 - 2.244
57	57.00 - 62.99	2.244 - 2.480
63	63.00 - 69.99	2.480 - 2.756
70	70.00 - 75.99	2.756 - 2.992
76	76.00 - 82.99	2.992 - 3.268
83	83.00 - 88.99	3.268 - 3.504
89	89.00 - 94.99	3.504 - 3.740
95	95.00 - 101.60	3.740 - 4.000

Introduction Information

Drill Selection Guide / Assembly Details	2 - 3
Pilot Insert Options / Details	4
Product Nomenclature	5

Drill Series

33 Series	6 - 7
38 Series	8 - 9
44 Series	10 - 11
51 Series	12 - 13
57 Series	14 - 15
63 Series	16 - 17
70 Series	18 - 19
76 Series	20 - 21
83 Series	22 - 23
89 Series	24 - 25
95 Series	26 - 27

Recommended Cutting Data

Metric (mm)	28
Imperial (inch)	29
Deep Hole Drilling Guidelines	30

Drill Selection Guide

Series	33	38	44	51	57
Page	6 - 7	8 - 9	10 - 11	12 - 13	14 - 15
D ₅ mm	33.00 - 37.99	38.00 - 43.99	44.00 - 50.99	51.00 - 56.99	57.00 - 62.99
D ₅ inch	1.2992 - 1.4688	1.4961 - 1.7322	1.7323 - 2.0075	2.0076 - 2.2438	2.2439 - 2.4799
ISO Material					
IC Insert Shape					
IC Insert Size (mm)	7.94	9.53	9.53, 12.70	12.70, 14.29	14.29
IC Insert Size (inch)	5/16"	3/8"	3/8", 1/2"	1/2", 9/16"	9/16"
Wear Pads	NO	NO	NO	NO	NO
Holders					
Drill Depth (mm)	112.6 - 378.6	130.5 - 439.9	151.5 - 510.0	161.8 - 570.0	179.9 - 626.9
Drill Depth (inch)	4-7/16 - 14-29/32	5-1/8 - 17-1/4	6 - 20-1/8	6-3/8 - 22-3/8	7-1/8 - 24-3/4
Pilot Insert					
T-A Series	0, 1	0, 1	1	1	1, 2
GEN3SYS XT Pro Series	-	15, 17, 18, 20	17, 18, 22	18, 20, 22	22, 24, 26



T-A® Style Pilot Insert Head

- Utilises both T-A Pro and T-A inserts (0 - 2 series)
- Multiple geometry options are available to achieve optimal results in different types of applications

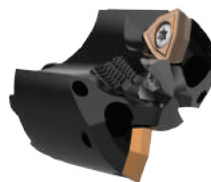

GEN3SYS® XT Style Pilot Insert Head

- Utilises GEN3SYS XT Pro inserts (15 - 32 series)
- ISO geometry options are available to achieve optimal results in different types of applications



IC Insert AM300®

- The design allows for excellent chip control and aggressive penetration rates
- The proprietary AM300 coatings increase tool life above competitors' premium coatings

Insert Application Recommendations

Carbide Grade Options

P35 (C5) General purpose carbide grade suitable for most applications.
▶ *Common application in steels and stainless steels.*

K35 (C1) Toughest carbide grade. Provides the best combination of edge strength and tool life.
▶ *Recommended for less rigid applications.*

K25 (C2) Higher wear-resistant carbide suitable for abrasive material applications.
▶ *Recommended for grey, ductile, and nodular irons.*

Additional Geometry Option

High Rake (HR) Provides superior chip control and tool life in long-chipping carbon and alloy steels below 200 Bhn.



Flanged Straight Shank



CAT40 / CAT50 Integral Shank

63	70	76	83	89	95
					
16 - 17	18 - 19	20 - 21	22 - 23	24 - 25	26 - 27
63.00 - 69.99	70.00 - 75.99	76.00 - 82.99	83.00 - 88.99	89.00 - 94.99	95.00 - 101.60
2.4800 - 2.7555	2.7556 - 2.9917	2.9918 - 3.2673	3.2674 - 3.5035	3.5036 - 3.7400	3.7401 - 4.0000
					
					
14.29	9.53	12.70	12.70	14.29	14.29
9/16"	3/8"	1/2"	1/2"	9/16"	9/16"
NO	YES	YES	YES	YES	YES
200.8 - 688.3	218.8 - 709.4	239.9 - 664.0	257.8 - 704.9	275.8 - 701.8	302.0 - 698.5
7-7/8 - 27-1/8	8-3/4 - 27-7/8	9-1/2 - 26-1/8	10-1/8 - 27-3/4	10-7/8 - 27-5/8	11-7/8 - 27-1/2
2	2	2	2	2	2
26, 29, 32	29	29	32	29	32



Step 1:

Lower the APX head assembly onto the APX holder.



Step 2:

Insert the head mounting screws into points A and B. Tighten until the head is properly secured to the holder.

Step 3:

Tighten with the head mounting driver using the torque setting chart below.

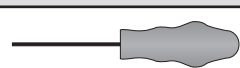
Torque Setting Chart

Series	Screw	Driver	Torque
33 - 63	75020-IP20-1	 8IP-20	678 N-cm (60 in-lb)
70 - 95	78027-IP30-1	 8IP-30B	2825 N-cm (250 in-lb)



Pilot Insert Options

A
DRILLING

B
BORING

C
REAMING

D
BURNISHING

E
THREADING

X
SPECIALS

T-A® Pilot Inserts

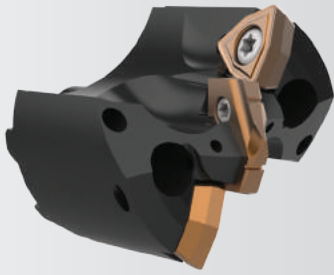

T-A Pro P - Steels

- Designed to provide increased penetration rates and tool life in steel applications
- Superior geometry and edge provides excellent chip control
- Allied's multilayer AM300 coating increases heat resistance and improves tool life

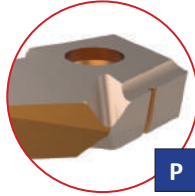

T-A Pro K - Cast Irons

- Uniquely designed for cast/ductile iron applications
- Geometry developed for maximum tool life, reduced exit burr, and improved hole finish
- Allied's multilayer TiAlN coating provides increased abrasion resistance and tool life

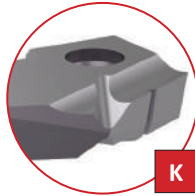

T-A Pro N - Non-ferrous Materials

- Designed for applications in aluminium, brass, and copper
- The geometry yields excellent chip control in these softer materials
- TiCN coating gives the versatility to run in a variety of materials while reducing buildup

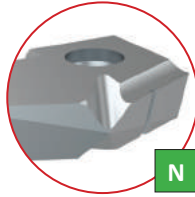

T-A Pro M - Stainless Steel

- Designed for all stainless steels and heat-resistant super alloys
- Geometry optimised for improved chip formation while minimizing exit burr
- Allied's new AM460 coating provides industry leading tool life in stainless and HRSA materials

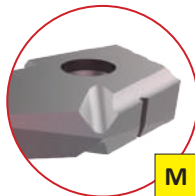

T-A Pro X - High-Speed Steel Materials

- Improved chip geometry for excellent chip control in all materials
- Long tool life and high-process security for the most challenging applications
- Allied's multilayer AM200 coating combines excellent heat resistance and high lubricity for wide application use



T-A Standard

- Excellent choice for general purpose use
- Provides fast penetration rates that produce good hole size and finish
- Combines highly efficient, stable cutting action to minimize power consumption

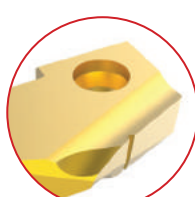

T-A Tiny Chip (-TC)

- Unique lip and point design for excellent chip control
- Improved capabilities in long-chipping materials such as low-carbon steels and soft alloy steels
- Enhanced performance in lower-powered machines for better chip formation at lower feed rates



T-A High Impact (-HI)

- Designed to enhance chip formation in materials with high elasticity/ductility and poor chip forming characteristics
- SK2 corner preparation for increased tool life
- Improves chip formation in structural, cast, and forged steels

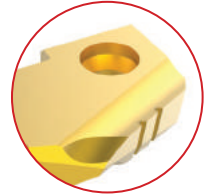

GEN3SYS® XT Pro Pilot Inserts

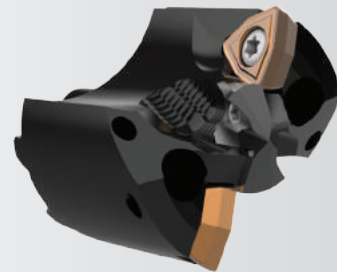

P - Steels

- Designed to provide increased penetration rates and tool life in steel applications
- Superior geometry and edge provides excellent chip control
- Allied's multilayer AM420 coating increases heat resistance and improves tool life

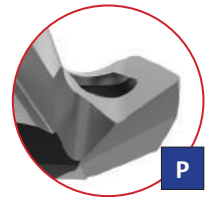

K - Cast Irons

- Uniquely designed for cast/nodular iron applications
- Geometry includes a corner radius for improved hole finish and heat dispersion
- Allied's multilayer AM440 coating provides increased abrasion resistance and tool life



N - Non-ferrous Materials

- Designed for applications in aluminium, brass, and copper
- The geometry yields excellent chip control in these softer materials
- TiN coating gives the versatility to run in a variety of materials while reducing buildup

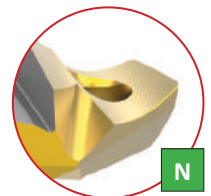

NOTE: For a complete offering of pilot inserts, see sections **A20** (GEN3SYS Drilling Systems), **A25** (T-A Pro Drilling Systems) and **A30** (T-A Drilling Systems) of our catalogue.

Product Nomenclature

APX Drill Heads

V	38	15	D	-	0116
1	2	3	4		5

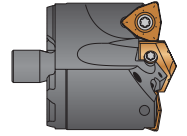

1. APX Head	2. Series		3. Pilot Series		
V = Head	33 = 33 series *	70 = 70 series	T-A® Pilot Insert	GEN3SYS® XT Pro Pilot Insert	
	38 = 38 series	76 = 76 series	00 = 0 series	15 = 15 series	24 = 24 series
	44 = 44 series	83 = 83 series	01 = 1 series	17 = 17 series	26 = 26 series
	51 = 51 series	89 = 89 series	02 = 2 series	18 = 18 series	29 = 29 series
	57 = 57 series	95 = 95 series		20 = 20 series	32 = 32 series
	63 = 63 series	*T-A® only		22 = 22 series	

4. Effective Cutting	5. Major Diameter
D = Double effective	68 = Metric
S = Single effective	1.5153 = Decimal
	0116 = Inch

Ordering Non-Stocked Diameters:

Non-stocked diameters are also available. Please refer to the price list for applicable process fees. Follow the ordering examples below:

- Metric: 38 series, T-A (1 series), 42.15 mm = **V3801D-42.15**
- Inch: 38 series, T-A (1 series), 1.6790" = **V3801D-1.6790**

APX Drill Holders

W	38	05	H	-	200F
1	2	3	4		5

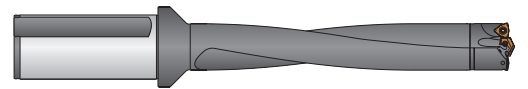

1. APX Holder	2. Series		3. Drill Length	4. Flute Style	5. Shank
W = Holder	33 = 33 series	70 = 70 series	03 = 3xD	H = Helical	150F = 1-1/2" flanged straight shank
	38 = 38 series	76 = 76 series	05 = 5xD		200F = 2" flanged straight shank
	44 = 44 series	83 = 83 series	08 = 8xD		40FM = 40 mm flanged straight shank
	51 = 51 series	89 = 89 series	10 = 10xD		50FM = 50 mm flanged straight shank
	57 = 57 series	95 = 95 series			CV40 = CAT40 integral shank
	63 = 63 series				CV50 = CAT50 integral shank

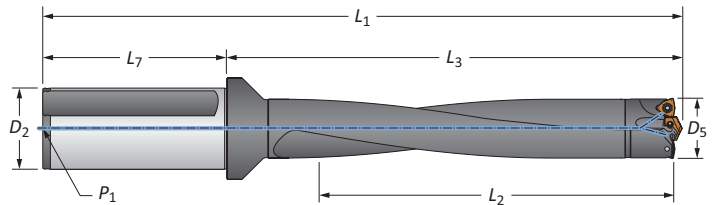
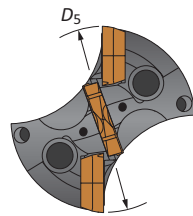
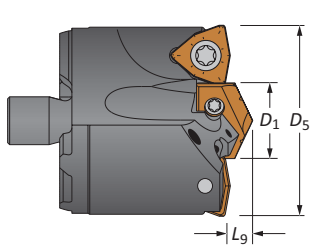

Reference Key

Symbol	Attribute
D₁	Pilot insert diameter
D₅	Major cutting diameter
L₉	Pilot insert length

Reference Key

Symbol	Attribute	Symbol	Attribute
D₂	Shank diameter	L₃	Holder reference length
D₅	Drill diameter range	L₇	Shank length
L₁	Overall length	P₁	Rear pipe tap
L₂	Drill depth		

33

 DRILLING | APX™ Drill: Deep Hole / Large Diameter Replaceable Insert Drilling System

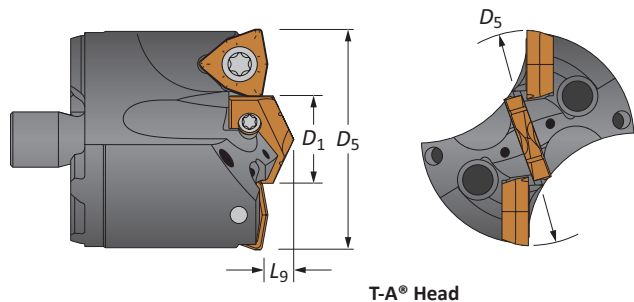

APX Drill Heads

33 Series | Diameter Range: 33.00 mm - 37.99 mm (1.299" - 1.496")





T-A® Head

Heads

Head					T-A Head				IC Insert Size	
D_5 metric	D_5 inch	D_5 fractional	D_1	L_9	Part No.	Pilot Series	 T-A Pro Insert	 T-A (-TC) Insert	metric	inch
33.00	1.299	-	16.00	6.35	V3300D-33	0	TA#0-16.00	1C10H-16-TC	7.94	5/16
33.34	1.313	1-5/16	16.00	6.35	V3300D-0110	0	TA#0-16.00	1C10H-16-TC	7.94	5/16
34.00	1.339	-	18.00	6.35	V3301D-34	1	TA#1-18.00	1C11H-18-TC	7.94	5/16
34.13	1.344	1-11/32	18.00	6.35	V3301D-0111	1	TA#1-18.00	1C11H-18-TC	7.94	5/16
34.93	1.375	1-3/8	18.00	6.35	V3301D-0112	1	TA#1-18.00	1C11H-18-TC	7.94	5/16
35.00	1.378	-	18.00	6.35	V3301D-35	1	TA#1-18.00	1C11H-18-TC	7.94	5/16
35.72	1.406	1-13/32	18.00	6.35	V3301D-0113	1	TA#1-18.00	1C11H-18-TC	7.94	5/16
36.00	1.417	-	20.00	6.35	V3301D-36	1	TA#1-20.00	1C11H-20-TC	7.94	5/16
36.51	1.438	1-7/16	20.00	6.35	V3301D-0114	1	TA#1-20.00	1C11H-20-TC	7.94	5/16
37.00	1.457	-	20.00	6.35	V3301D-37	1	TA#1-20.00	1C11H-20-TC	7.94	5/16
37.31	1.469	1-15/32	20.00	6.35	V3301D-0115	1	TA#1-20.00	1C11H-20-TC	7.94	5/16

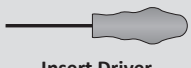

#Denotes ISO material/geometry (P= steel, K= cast iron, N= non-ferrous)

IC Inserts

Coating	Size		Grade	Geometry	 Part No.	 Insert Screw	 Insert Driver	Admissible Tightening Torque*
	metric	inch						
AM300®	7.94	5/16	P35 (C5)	Standard	OP-05T308-PW	IS-10-1	8IP-10	305 N-cm (27.0 in-lbs)
AM300®	7.94	5/16	K35 (C1)	Standard	OP-05T308-1PW	IS-10-1	8IP-10	305 N-cm (27.0 in-lbs)
AM300®	7.94	5/16	K25 (C2)	Standard	OP-05T308-2PW	IS-10-1	8IP-10	305 N-cm (27.0 in-lbs)
AM300®	7.94	5/16	P35 (C5)	High Rake	OP-05T308-PWHR	IS-10-1	8IP-10	305 N-cm (27.0 in-lbs)

 *Tightening torques are calculated with a friction coefficient of $\mu = 0.14$ and develop 90% of ultimate yield strength

Pilot Accessories

Pilot Style	Series	 Insert Screws	 Insert Driver	Admissible Tightening Torque*
T-A	0	72567-IP8-1	8IP-8	175 N-cm (15.5 in-lbs)
T-A	1	7375-IP9-1	8IP-9	305 N-cm (27.0 in-lbs)

 *Tightening torques are calculated with a friction coefficient of $\mu = 0.14$ and develop 90% of ultimate yield strength

A50: 28 - 29

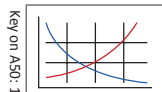

A50: 2 - 5



Section A25 & A30

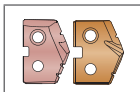

Non-stocked diameters are also available. Follow the examples shown below.

Metric	38 series, T-A (1 series), 42.15 mm	Part No. = V3801D-42.15
Inch	38 series, T-A (1 series), 1.6790"	Part No. = V3801D-1.6790

IC inserts sold in multiples of 2 | Insert screws sold in multiples of 10

A50: 6

www.alliedmachine.com | +44 (0) 1384 400 900 | enquiries.eu@alliedmachine.com

 A
DRILLING

 B
BORING

 C
REAMING

 D
BURNISHING

 E
THREADING

 X
SPECIALS

APX Drill Holders

33 Series | Diameter Range: 33.00 mm - 37.99 mm (1.299" - 1.496")

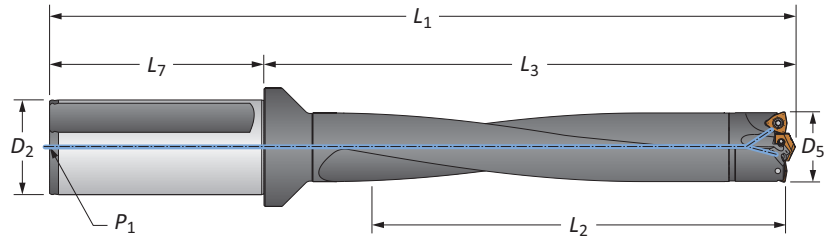

Straight Shank

	Length	D_5		Body			Shank		Part No.	
		mm	inch	L_2	L_3	L_1	L_7	D_2		P_1
m	3xD	33.00 - 37.99		112.60	167.49	237.49	70.00	40.00	1/4 BSPT	W3303H-40FM
	5xD	33.00 - 37.99		188.60	243.41	313.41	70.00	40.00	1/4 BSPT	W3305H-40FM
	8xD	33.00 - 37.99		302.60	357.40	427.40	70.00	40.00	1/4 BSPT	⚠ W3308H-40FM
	10xD	33.00 - 37.99		378.61	433.40	503.40	70.00	40.00	1/4 BSPT	⚠ W3310H-40FM
i	3xD	1.299 - 1.496		4-7/16	6-19/32	9-9/32	2-11/16	1-1/2	1/4 NPT	W3303H-150F
	5xD	1.299 - 1.496		7-27/64	9-37/64	12-9/32	2-11/16	1-1/2	1/4 NPT	W3305H-150F
	8xD	1.299 - 1.496		11-59/64	14-5/64	16-3/4	2-11/16	1-1/2	1/4 NPT	⚠ W3308H-150F
	10xD	1.299 - 1.496		14-29/32	17-1/16	19-3/4	2-11/16	1-1/2	1/4 NPT	⚠ W3310H-150F

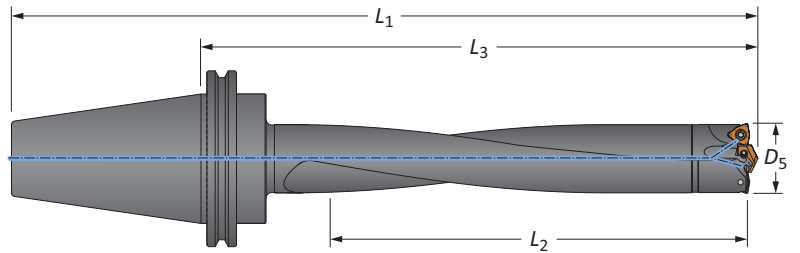

CAT Integral Shank

	Length	D_5		Body			Shank	Part No.	
		mm	inch	L_2	L_3	L_1			
i	3xD	33.00 - 37.99		1.299 - 1.496	4-7/16	7-3/8	10-3/16	CV40	W3303H-CV40
	5xD	33.00 - 37.99		1.299 - 1.496	7-27/64	10-23/64	13-11/64	CV40	W3305H-CV40
	8xD	33.00 - 37.99		1.299 - 1.496	11-59/64	14-55/64	17-21/32	CV40	⚠ W3308H-CV40
	10xD	33.00 - 37.99		1.299 - 1.496	14-29/32	17-27/32	20-21/32	CV40	⚠ W3310H-CV40
i	3xD	33.00 - 37.99		1.299 - 1.496	4-7/16	7-3/8	11-1/2	CV50	W3303H-CV50
	5xD	33.00 - 37.99		1.299 - 1.496	7-27/64	10-23/64	14-31/64	CV50	W3305H-CV50
	8xD	33.00 - 37.99		1.299 - 1.496	11-59/64	14-55/64	18-31/32	CV50	⚠ W3308H-CV50
	10xD	33.00 - 37.99		1.299 - 1.496	14-29/32	17-27/32	21-31/32	CV50	⚠ W3310H-CV50

Connection Accessories

		Admissible Tightening Torque*
Mounting Screw 75020-IP20-1	Mounting Screw Driver 8IP-20	
		678 N-cm (60 in-lb)

*Tightening torques are calculated with a friction coefficient of $\mu = 0.14$ and develop 90% of ultimate yield strength

⚠ WARNING Refer to Speed and Feed charts for recommended adjustments to speeds and feeds. Refer to page A50: 30 for deep hole drilling guidelines in this section of the catalogue. Visit www.alliedmachine.com/DeepHoleGuidelines for the most up-to-date information and procedures. Factory technical assistance is available for your specific applications through our Application Engineering Team.
email: engineering.eu@alliedmachine.com

m = Metric (mm)
i = Imperial (in)

Mounting screws sold in multiples of 4

38

 DRILLING | APX™ Drill: Deep Hole / Large Diameter Replaceable Insert Drilling System

APX Drill Heads

38 Series | Diameter Range: 38.00 mm - 43.99 mm (1.496" - 1.732")

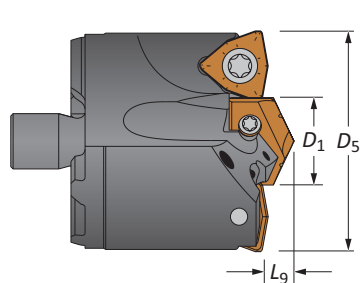

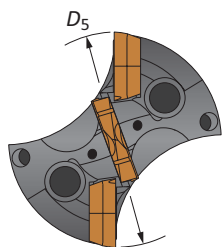
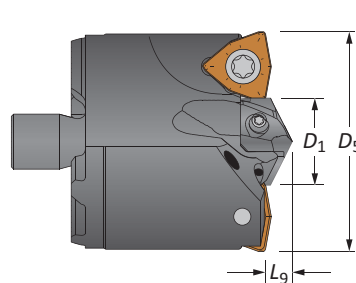

T-A® Head

GEN3SYS® XT Pro Head

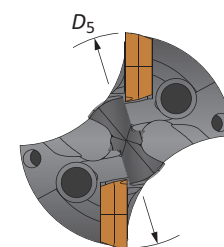



Heads

Head					T-A Head				GEN3SYS XT Pro Head				
D_5 metric	D_5 inch	D_5 fractional	D_1	L_9	Part No.	Pilot Series	 T-A Pro Insert	 T-A (-TC) Insert	Part No.	Pilot Series	 Pilot Insert	IC Insert Size	
												metric	inch
38.00	1.496	-	15.50	7.54	V3800D-38	0	TA#0-15.50	1C10H-15.5-TC	V3815D-38	15	XT#15-15.50	9.53	3/8
38.10	1.500	1-1/2	15.50	7.54	V3800D-0116	0	TA#0-15.50	1C10H-15.5-TC	V3815D-0116	15	XT#15-15.50	9.53	3/8
38.90	1.531	1-17/32	15.50	7.54	V3800D-0117	0	TA#0-15.50	1C10H-15.5-TC	V3815D-0117	15	XT#15-15.50	9.53	3/8
39.00	1.535	-	15.50	7.54	V3800D-39	0	TA#0-15.50	1C10H-15.5-TC	V3815D-39	15	XT#15-15.50	9.53	3/8
39.69	1.563	1-9/16	15.50	7.54	V3800D-0118	0	TA#0-15.50	1C10H-15.5-TC	V3815D-0118	15	XT#15-15.50	9.53	3/8
40.00	1.575	-	17.50	7.54	V3800D-40	0	TA#0-17.50	1C10H-17.5-TC	V3817D-40	17	XT#17-17.50	9.53	3/8
40.48	1.594	1-19/32	17.50	7.54	V3800D-0119	0	TA#0-17.50	1C10H-17.5-TC	V3817D-0119	17	XT#17-17.50	9.53	3/8
41.00	1.614	-	17.50	7.54	V3800D-41	0	TA#0-17.50	1C10H-17.5-TC	V3817D-41	17	XT#17-17.50	9.53	3/8
41.28	1.625	1-5/8	17.50	7.54	V3800D-0120	0	TA#0-17.50	1C10H-17.5-TC	V3817D-0120	17	XT#17-17.50	9.53	3/8
42.00	1.654	-	19.50	7.54	V3801D-42	1	TA#1-19.50	1C11H-19.5-TC	V3818D-42	18	XT#18-19.50	9.53	3/8
42.07	1.656	1-21/32	19.50	7.54	V3801D-0121	1	TA#1-19.50	1C11H-19.5-TC	V3818D-0121	18	XT#18-19.50	9.53	3/8
42.86	1.688	1-11/16	19.50	7.54	V3801D-0122	1	TA#1-19.50	1C11H-19.5-TC	V3818D-0122	18	XT#18-19.50	9.53	3/8
43.00	1.693	-	21.00	7.54	V3801D-43	1	TA#1-21.00	1C11H-21-TC	V3820D-43	20	XT#20-21.00	9.53	3/8
43.66	1.719	1-23/32	21.00	7.54	V3801D-0123	1	TA#1-21.00	1C11H-21-TC	V3820D-0123	20	XT#20-21.00	9.53	3/8

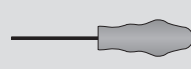

#Denotes ISO material/geometry (P= steel, K= cast iron, N= non-ferrous)

IC Inserts

Coating	Size		Grade	Geometry	 Part No.	 Insert Screw	 Insert Driver	Admissible Tightening Torque*
	metric	inch						
AM300®	9.53	3/8	P35 (C5)	Standard	OP-060408-PW	73595-IP15-1	8IP-15	465 N-cm (41.0 in-lbs)
AM300®	9.53	3/8	K35 (C1)	Standard	OP-060408-1PW	73595-IP15-1	8IP-15	465 N-cm (41.0 in-lbs)
AM300®	9.53	3/8	K25 (C2)	Standard	OP-060408-2PW	73595-IP15-1	8IP-15	465 N-cm (41.0 in-lbs)
AM300®	9.53	3/8	P35 (C5)	High Rake	OP-060408-PWHR	73595-IP15-1	8IP-15	465 N-cm (41.0 in-lbs)

*Tightening torques are calculated with a friction coefficient of $\mu = 0.14$ and develop 90% of ultimate yield strength

Pilot Accessories

Pilot Style	Series	 Insert Screws	 Insert Driver	Admissible Tightening Torque*
T-A	0	72567-IP8-1	8IP-8	175 N-cm (15.5 in-lbs)
T-A	1	7375-IP9-1	8IP-9	305 N-cm (27.0 in-lbs)
GEN3SYS	15	7247-IP7-1	8IP-7	84 N-cm (7.4 in-lbs)
GEN3SYS	17	72567-IP8-1	8IP-8	175 N-cm (15.5 in-lbs)
GEN3SYS	18	7375-IP9-1	8IP-9	305 N-cm (27.0 in-lbs)
GEN3SYS	20	7375-IP9-1	8IP-9	305 N-cm (27.0 in-lbs)

*Tightening torques are calculated with a friction coefficient of $\mu = 0.14$ and develop 90% of ultimate yield strength

 A50: 28 - 29
  A50: 2 - 5
  Section A20
  Section A25 & A30

Non-stocked diameters are also available. Follow the examples shown below.

Metric	38 series, T-A (1 series), 42.15 mm	Part No. = V3801D-42.15
Inch	38 series, T-A (1 series), 1.6790"	Part No. = V3801D-1.6790

IC inserts sold in multiples of 2 | Insert screws sold in multiples of 10

A50: 8

www.alliedmachine.com | +44 (0) 1384 400 900 | enquiries.eu@alliedmachine.com

A DRILLING

B BORING

C REAMING

D BURISHING

E THREADING

X SPECIALS

APX Drill Holders

38 Series | Diameter Range: 38.00 mm - 43.99 mm (1.496" - 1.732")

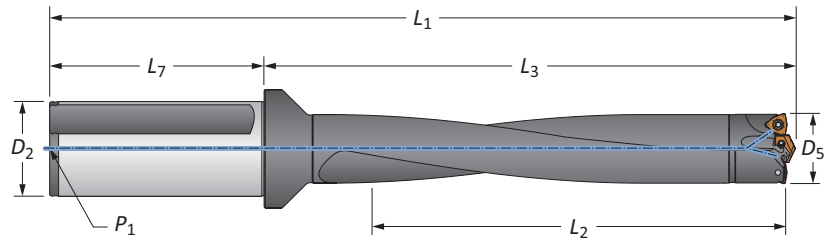

Straight Shank

	Length	D ₅	Body			L ₇	Shank		Part No.
			L ₂	L ₃	L ₁		D ₂	P ₁	
m	3xD	38.00 - 43.99	130.51	196.49	265.71	70.00	40.00	1/4 BSPT	W3803H-40FM
	5xD	38.00 - 43.99	219.99	284.51	353.70	70.00	40.00	1/4 BSPT	W3805H-40FM
	8xD	38.00 - 43.99	351.99	416.51	485.70	70.00	40.00	1/4 BSPT	⚠ W3808H-40FM
	10xD	38.00 - 43.99	439.90	503.91	573.71	70.00	40.00	1/4 BSPT	⚠ W3810H-40FM
	3xD	38.00 - 43.99	130.51	196.49	276.50	80.00	50.00	1/4 BSPT	W3803H-50FM
	5xD	38.00 - 43.99	219.99	284.51	364.49	80.00	50.00	1/4 BSPT	W3805H-50FM
	8xD	38.00 - 43.99	351.99	416.51	496.99	80.00	50.00	1/4 BSPT	⚠ W3808H-50FM
	10xD	38.00 - 43.99	439.90	503.90	583.91	80.00	50.00	1/4 BSPT	⚠ W3810H-50FM
i	3xD	1.496 - 1.732	5-1/8	7-47/64	10-25/64	2-11/16	1-1/2	1/4 NPT	W3803H-150F
	5xD	1.496 - 1.732	8-5/8	11-13/64	13-55/64	2-11/16	1-1/2	1/4 NPT	W3805H-150F
	8xD	1.496 - 1.732	13-7/8	16-25/64	19-3/64	2-11/16	1-1/2	1/4 NPT	⚠ W3808H-150F
	10xD	1.496 - 1.732	17-1/4	19-27/32	22-33/64	2-11/16	1-1/2	1/4 NPT	⚠ W3810H-150F
	3xD	1.496 - 1.732	5-1/8	7-47/64	12-15/64	4-1/2	2	1/4 NPT	W3803H-200F
	5xD	1.496 - 1.732	8-5/8	11-13/64	15-45/64	4-1/2	2	1/4 NPT	W3805H-200F
	8xD	1.496 - 1.732	13-7/8	16-25/64	20-57/64	4-1/2	2	1/4 NPT	⚠ W3808H-200F
	10xD	1.496 - 1.732	17-1/4	19-27/32	24-59/64	4-1/2	2	1/4 NPT	⚠ W3810H-200F

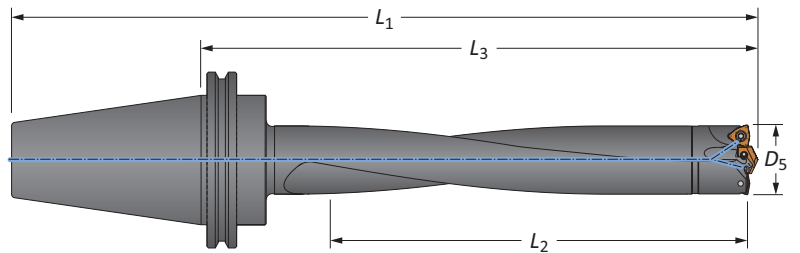

CAT Integral Shank

	Length	D ₅		Body			Shank	Part No.
		mm	inch	L ₂	L ₃	L ₁		
i	3xD	38.00 - 43.99	1.496 - 1.732	5-1/8	8-5/16	11	CV40	W3803H-CV40
	5xD	38.00 - 43.99	1.496 - 1.732	8-5/8	11-49/64	14-29/64	CV40	W3805H-CV40
	8xD	38.00 - 43.99	1.496 - 1.732	13-7/8	16-31/32	19-21/32	CV40	⚠ W3808H-CV40
	10xD	38.00 - 43.99	1.496 - 1.732	17-1/4	20-7/16	23-1/8	CV40	⚠ W3810H-CV40
	3xD	38.00 - 43.99	1.496 - 1.732	5-1/8	8-5/16	12-5/16	CV50	W3803H-CV50
	5xD	38.00 - 43.99	1.496 - 1.732	8-5/8	11-49/64	15-49/64	CV50	W3805H-CV50
	8xD	38.00 - 43.99	1.496 - 1.732	13-7/8	16-31/32	20-31/32	CV50	⚠ W3808H-CV50
	10xD	38.00 - 43.99	1.496 - 1.732	17-1/4	20-7/16	24-7/16	CV50	⚠ W3810H-CV50

Connection Accessories

Mounting Screw	Mounting Screw Driver	Admissible Tightening Torque*
75020-IP20-1	8IP-20	678 N-cm (60 in-lb)

*Tightening torques are calculated with a friction coefficient of $\mu = 0.14$ and develop 90% of ultimate yield strength

⚠ WARNING Refer to Speed and Feed charts for recommended adjustments to speeds and feeds. Refer to page A50: 30 for deep hole drilling guidelines in this section of the catalogue. Visit www.alliedmachine.com/DeepHoleGuidelines for the most up-to-date information and procedures. Factory technical assistance is available for your specific applications through our Application Engineering Team. email: engineering.eu@alliedmachine.com

m = Metric (mm)
i = Imperial (in)

Mounting screws sold in multiples of 4

APX Drill Heads

44 Series | Diameter Range: 44.00 mm - 50.99 mm (1.732" - 2.008")

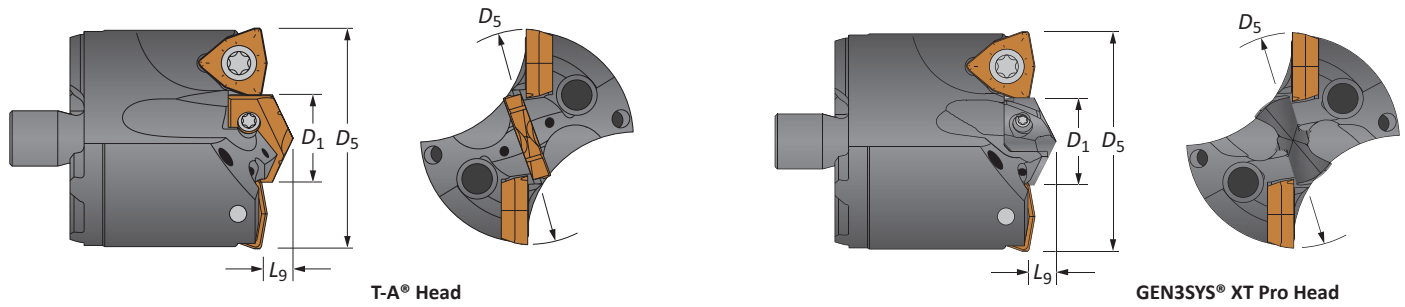

Head					T-A Head				GEN3SYS XT Pro Head				
D_5 metric	D_5 inch	D_5 fractional	D_1	L_9	Part No.	Pilot Series	T-A Pro Insert	T-A (-TC) Insert	Part No.	Pilot Series	Pilot Insert	IC Insert Size metric	IC Insert Size inch
44.00	1.732	-	23.00	8.33	V4401D-44	1	TA#1-23.00	1C11H-23-TC	V4422D-44	22	XT#22-23.00	9.53	3/8
44.45	1.750	1-3/4	23.00	8.33	V4401D-0124	1	TA#1-23.00	1C11H-23-TC	V4422D-0124	22	XT#22-23.00	9.53	3/8
45.00	1.772	-	23.00	8.33	V4401D-45	1	TA#1-23.00	1C11H-23-TC	V4422D-45	22	XT#22-23.00	9.53	3/8
45.25	1.781	1-25/32	23.00	8.33	V4401D-0125	1	TA#1-23.00	1C11H-23-TC	V4422D-0125	22	XT#22-23.00	9.53	3/8
46.00	1.811	-	24.00	8.33	V4401D-46	1	TA#1-24.00	1C11H-24-TC	V4422D-46	22	XT#22-23.80	9.53	3/8
46.04	1.813	1-13/16	24.00	8.33	V4401D-0126	1	TA#1-24.00	1C11H-24-TC	V4422D-0126	22	XT#22-23.80	9.53	3/8
46.83	1.844	1-27/32	24.00	8.33	V4401D-0127	1	TA#1-24.00	1C11H-24-TC	V4422D-0127	22	XT#22-23.80	9.53	3/8
47.00	1.850	-	24.00	8.33	V4401D-47	1	TA#1-24.00	1C11H-24-TC	V4422D-47	22	XT#22-23.80	9.53	3/8
47.63	1.875	1-7/8	24.00	8.33	V4401D-0128	1	TA#1-24.00	1C11H-24-TC	V4422D-0128	22	XT#22-23.80	9.53	3/8
48.00	1.890	-	18.00	8.33	V4401D-48	1	TA#1-18.00	1C11H-18-TC	V4417D-48	17	XT#17-17.90	12.70	1/2
48.42	1.906	1-29/32	18.00	8.33	V4401D-0129	1	TA#1-18.00	1C11H-18-TC	V4417D-0129	17	XT#17-17.90	12.70	1/2
49.00	1.929	-	18.00	8.33	V4401D-49	1	TA#1-18.00	1C11H-18-TC	V4417D-49	17	XT#17-17.90	12.70	1/2
49.21	1.938	1-15/16	18.00	8.33	V4401D-0130	1	TA#1-18.00	1C11H-18-TC	V4417D-0130	17	XT#17-17.90	12.70	1/2
50.00	1.969	-	19.00	8.33	V4401D-50	1	TA#1-19.00	1C11H-19-TC	V4418D-50	18	XT#18-19.00	12.70	1/2
50.01	1.969	1-31/32	19.00	8.33	V4401D-0131	1	TA#1-19.00	1C11H-19-TC	V4418D-0131	18	XT#18-19.00	12.70	1/2
50.80	2.000	2	19.00	8.33	V4401D-0200	1	TA#1-19.00	1C11H-19-TC	V4418D-0200	18	XT#18-19.00	12.70	1/2

#Denotes ISO material/geometry (P= steel, K= cast iron, N= non-ferrous)

IC Inserts

Coating	Size		Grade	Geometry	Part No.	Insert Screw	Insert Driver	Admissible Tightening Torque*
	metric	inch						
AM300®	9.53	3/8	P35 (C5)	Standard	OP-060408-PW	73595-IP15-1	8IP-15	465 N-cm (41.0 in-lbs)
AM300®	9.53	3/8	K35 (C1)	Standard	OP-060408-1PW	73595-IP15-1	8IP-15	465 N-cm (41.0 in-lbs)
AM300®	9.53	3/8	K25 (C2)	Standard	OP-060408-2PW	73595-IP15-1	8IP-15	465 N-cm (41.0 in-lbs)
AM300®	9.53	3/8	P35 (C5)	High Rake	OP-060408-PWHR	73595-IP15-1	8IP-15	465 N-cm (41.0 in-lbs)
AM300®	12.70	1/2	P35 (C5)	Standard	OP-080508-PW	74012-IP15-1	8IP-15	690 N-cm (61.0 in-lbs)
AM300®	12.70	1/2	K35 (C1)	Standard	OP-080508-1PW	74012-IP15-1	8IP-15	690 N-cm (61.0 in-lbs)
AM300®	12.70	1/2	K25 (C2)	Standard	OP-080508-2PW	74012-IP15-1	8IP-15	690 N-cm (61.0 in-lbs)
AM300®	12.70	1/2	P35 (C5)	High Rake	OP-080508-PWHR	74012-IP15-1	8IP-15	690 N-cm (61.0 in-lbs)

*Tightening torques are calculated with a friction coefficient of $\mu = 0.14$ and develop 90% of ultimate yield strength

Pilot Accessories

Pilot Style	Series	Insert Screws	Insert Driver	Admissible Tightening Torque*
T-A	1	7375-IP9-1	8IP-9	305 N-cm (27.0 in-lbs)
GEN3SYS	17	72567-IP8-1	8IP-8	175 N-cm (15.5 in-lbs)
GEN3SYS	18	7375-IP9-1	8IP-9	305 N-cm (27.0 in-lbs)
GEN3SYS	22	739-IP9-1	8IP-9	305 N-cm (27.0 in-lbs)

*Tightening torques are calculated with a friction coefficient of $\mu = 0.14$ and develop 90% of ultimate yield strength

A50: 28 - 29 A50: 2 - 5 Section A20 Section A25 & A30

Non-stocked diameters are also available. Follow the examples shown below.

Metric	38 series, T-A (1 series), 42.15 mm	Part No. = V3801D-42.15
Inch	38 series, T-A (1 series), 1.6790"	Part No. = V3801D-1.6790

IC inserts sold in multiples of 2 | Insert screws sold in multiples of 10

APX Drill Holders

44 Series | Diameter Range: 44.00 mm - 50.99 mm (1.732" - 2.008")

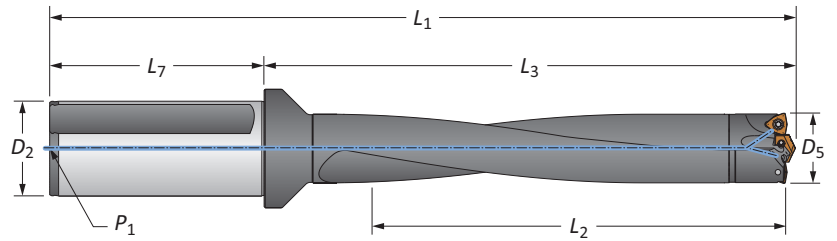

Straight Shank

	Length	D ₅	Body			Shank		Part No.	
			L ₂	L ₃	L ₁	L ₇	D ₂		P ₁
m	3xD	44.00 - 50.99	152.00	216.79	286.89	70.00	40.00	1/4 BSPT	W4403H-40FM
	5xD	44.00 - 50.99	255.00	318.80	388.90	70.00	40.00	1/4 BSPT	W4405H-40FM
	8xD	44.00 - 50.99	408.00	471.81	541.81	70.00	40.00	1/4 BSPT	⚠ W4408H-40FM
	10xD	44.00 - 50.99	510.01	573.81	643.79	70.00	40.00	1/4 BSPT	⚠ W4410H-40FM
	3xD	44.00 - 50.99	152.00	216.79	296.90	80.00	50.00	1/4 BSPT	W4403H-50FM
	5xD	44.00 - 50.99	255.00	318.80	398.80	80.00	50.00	1/4 BSPT	W4405H-50FM
	8xD	44.00 - 50.99	409.00	471.70	551.69	80.00	50.00	1/4 BSPT	⚠ W4408H-50FM
	10xD	44.00 - 50.99	510.01	573.81	653.80	80.00	50.00	1/4 BSPT	⚠ W4410H-50FM
i	3xD	1.732 - 2.008	6	8-17/32	11-15/64	2-11/16	1-1/2	1/4 NPT	W4403H-150F
	5xD	1.732 - 2.008	10	12-35/64	15-1/4	2-11/16	1-1/2	1/4 NPT	W4405H-150F
	8xD	1.732 - 2.008	16	18-37/64	21-17/64	2-11/16	1-1/2	1/4 NPT	⚠ W4408H-150F
	10xD	1.732 - 2.008	20-1/8	22-19/32	25-9/32	2-11/16	1-1/2	1/4 NPT	⚠ W4410H-150F
	3xD	1.732 - 2.008	6	8-33/64	13-1/32	4-1/2	2	1/4 NPT	W4403H-200F
	5xD	1.732 - 2.008	10	12-35/64	17-3/64	4-1/2	2	1/4 NPT	W4405H-200F
	8xD	1.732 - 2.008	16	18-37/64	23-5/64	4-1/2	2	1/4 NPT	⚠ W4408H-200F
	10xD	1.732 - 2.008	20-1/8	22-19/32	27-3/32	4-1/2	2	1/4 NPT	⚠ W4410H-200F

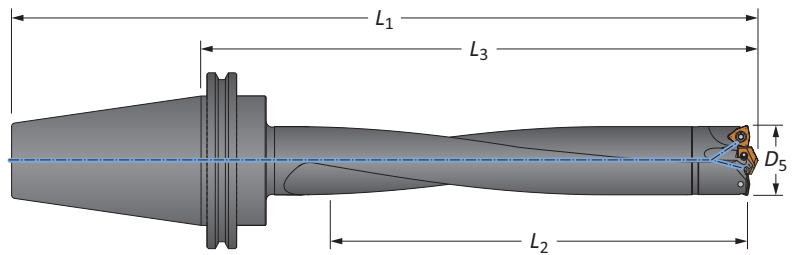

CAT Integral Shank

	Length	D ₅		Body			Shank	Part No.
		mm	inch	L ₂	L ₃	L ₁		
i	3xD	44.00 - 50.99	1.732 - 2.008	6	9-1/4	11-15/16	CV40	W4403H-CV40
	5xD	44.00 - 50.99	1.732 - 2.008	10	13-17/64	15-61/64	CV40	W4405H-CV40
	8xD	44.00 - 50.99	1.732 - 2.008	16	19-19/64	21-63/64	CV40	⚠ W4408H-CV40
	10xD	44.00 - 50.99	1.732 - 2.008	20-1/8	23-5/16	26	CV40	⚠ W4410H-CV40
	3xD	44.00 - 50.99	1.732 - 2.008	6	9-1/4	13-1/4	CV50	W4403H-CV50
	5xD	44.00 - 50.99	1.732 - 2.008	10	13-17/64	17-17/64	CV50	W4405H-CV50
	8xD	44.00 - 50.99	1.732 - 2.008	16	19-19/64	23-19/64	CV50	⚠ W4408H-CV50
	10xD	44.00 - 50.99	1.732 - 2.008	20	23-5/16	27-5/16	CV50	⚠ W4410H-CV50

Connection Accessories

Mounting Screw	Mounting Screw Driver	Admissible Tightening Torque*
75020-IP20-1	8IP-20	678 N-cm (60 in-lb)

*Tightening torques are calculated with a friction coefficient of $\mu = 0.14$ and develop 90% of ultimate yield strength

⚠ WARNING Refer to Speed and Feed charts for recommended adjustments to speeds and feeds. Refer to page A50: 30 for deep hole drilling guidelines in this section of the catalogue. Visit www.alliedmachine.com/DeepHoleGuidelines for the most up-to-date information and procedures. Factory technical assistance is available for your specific applications through our Application Engineering Team.
email: engineering.eu@alliedmachine.com

m = Metric (mm)
i = Imperial (in)

Mounting screws sold in multiples of 4

APX Drill Heads

51 Series | Diameter Range: 51.00 mm - 56.99 mm (2.008" - 2.244")

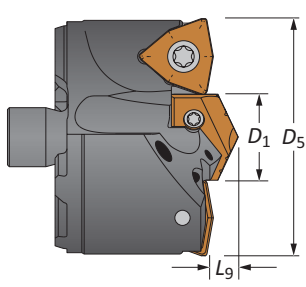

T-A® Head

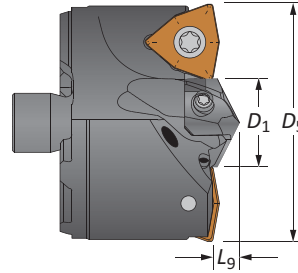
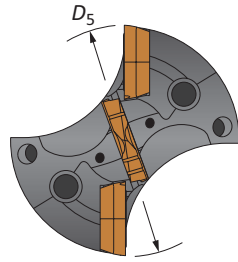

GEN3SYS® XT Pro Head

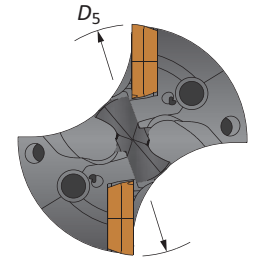

Heads

Head					T-A Head				GEN3SYS XT Pro Head						
D ₅ metric	D ₅ inch	D ₅ fractional	D ₁	L ₉	Part No.	Pilot Series	T-A Pro Insert	T-A (-TC) Insert	Part No.	Pilot Series	Pilot Insert	IC Insert Size			
														metric	inch
51.00	2.008	-	20.00	8.73	V5101D-51	1	TA#1-20.00	1C11H-20-TC	V5118D-51	18	XT#18-19.80	12.70	1/2		
51.59	2.031	2-1/32	20.00	8.73	V5101D-0201	1	TA#1-20.00	1C11H-20-TC	V5118D-0201	18	XT#18-19.80	12.70	1/2		
52.00	2.047	-	20.00	8.73	V5101D-52	1	TA#1-20.00	1C11H-20-TC	V5118D-52	18	XT#18-19.80	12.70	1/2		
52.39	2.063	2-1/16	20.00	8.73	V5101D-0202	1	TA#1-20.00	1C11H-20-TC	V5118D-0202	18	XT#18-19.80	12.70	1/2		
53.00	2.087	-	21.50	8.73	V5101D-53	1	TA#1-21.50	1C11H-21.5-TC	V5120D-53	20	XT#20-21.50	12.70	1/2		
53.18	2.094	2-3/32	21.50	8.73	V5101D-0203	1	TA#1-21.50	1C11H-21.5-TC	V5120D-0203	20	XT#20-21.50	12.70	1/2		
53.98	2.125	2-1/8	21.50	8.73	V5101D-0204	1	TA#1-21.50	1C11H-21.5-TC	V5120D-0204	20	XT#20-21.50	12.70	1/2		
54.00	2.126	-	24.00	8.73	V5101D-54	1	TA#1-24.00	1C11H-24-TC	V5122D-54	22	XT#22-23.80	12.70	1/2		
54.77	2.156	2-5/32	24.00	8.73	V5101D-0205	1	TA#1-24.00	1C11H-24-TC	V5122D-0205	22	XT#22-23.80	12.70	1/2		
55.00	2.165	-	24.00	8.73	V5101D-55	1	TA#1-24.00	1C11H-24-TC	V5122D-55	22	XT#22-23.80	12.70	1/2		
55.56	2.188	2-3/16	24.00	8.73	V5101D-0206	1	TA#1-24.00	1C11H-24-TC	V5122D-0206	22	XT#22-23.80	12.70	1/2		
56.00	2.205	-	24.00	8.73	V5101D-56	1	TA#1-24.00	1C11H-24-TC	V5122D-56	22	XT#22-23.80	12.70	1/2		
56.36	2.219	2-7/32	21.00	8.73	V5101D-0207	1	TA#1-21.00	1C11H-21-TC	V5120D-0207	20	XT#20-21.00	14.29	9/16		

#Denotes ISO material/geometry (P= steel, K= cast iron, N= non-ferrous)

IC Inserts

Coating	Size		Grade	Geometry	Part No.	Insert Screw	Insert Driver	Admissible Tightening Torque*
	metric	inch						
AM300®	12.70	1/2	P35 (C5)	Standard	OP-080508-PW	74012-IP15-1	8IP-15	690 N-cm (61.0 in-lbs)
AM300®	12.70	1/2	K35 (C1)	Standard	OP-080508-1PW	74012-IP15-1	8IP-15	690 N-cm (61.0 in-lbs)
AM300®	12.70	1/2	K25 (C2)	Standard	OP-080508-2PW	74012-IP15-1	8IP-15	690 N-cm (61.0 in-lbs)
AM300®	12.70	1/2	P35 (C5)	High Rake	OP-080508-PWHR	74012-IP15-1	8IP-15	690 N-cm (61.0 in-lbs)
AM300®	14.29	9/16	P35 (C5)	Standard	OP-090608-PW	75014-IP20-1	8IP-20	1370 N-cm (121.0 in-lbs)
AM300®	14.29	9/16	K35 (C1)	Standard	OP-090608-1PW	75014-IP20-1	8IP-20	1370 N-cm (121.0 in-lbs)
AM300®	14.29	9/16	K25 (C2)	Standard	OP-090608-2PW	75014-IP20-1	8IP-20	1370 N-cm (121.0 in-lbs)
AM300®	14.29	9/16	P35 (C5)	High Rake	OP-090608-PWHR	75014-IP20-1	8IP-20	1370 N-cm (121.0 in-lbs)

*Tightening torques are calculated with a friction coefficient of $\mu = 0.14$ and develop 90% of ultimate yield strength

Pilot Accessories

Pilot Style	Series	Insert Screws	Insert Driver	Admissible Tightening Torque*
T-A	1	7375-IP9-1	8IP-9	305 N-cm (27.0 in-lbs)
GEN3SYS	18	7375-IP9-1	8IP-9	305 N-cm (27.0 in-lbs)
GEN3SYS	20	7375-IP9-1	8IP-9	305 N-cm (27.0 in-lbs)
GEN3SYS	22	739-IP9-1	8IP-9	305 N-cm (27.0 in-lbs)

*Tightening torques are calculated with a friction coefficient of $\mu = 0.14$ and develop 90% of ultimate yield strength

A50: 28 - 29 A50: 2 - 5 Section A20 Section A25 & A30

Non-stocked diameters are also available. Follow the examples shown below.

Metric	38 series, T-A (1 series), 42.15 mm	Part No. = V3801D-42.15
Inch	38 series, T-A (1 series), 1.6790"	Part No. = V3801D-1.6790

IC inserts sold in multiples of 2 | Insert screws sold in multiples of 10

APX Drill Holders

51 Series | Diameter Range: 51.00 mm - 56.99 mm (2.008" - 2.244")

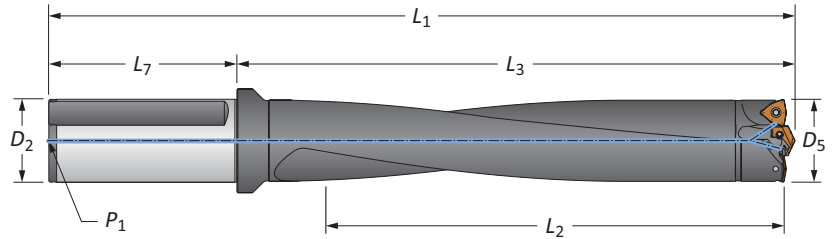

Straight Shank

	Length	D ₅	Body			Shank			Part No.
			L ₂	L ₃	L ₁	L ₇	D ₂	P ₁	
m	3xD	51.00 - 56.99	161.80	225.50	305.51	80.00	50.00	1/4 BSPT	W5103H-50FM
	5xD	51.00 - 56.99	284.99	339.60	419.61	80.00	50.00	1/4 BSPT	W5105H-50FM
	8xD	51.00 - 56.99	455.90	510.49	590.50	80.00	50.00	1/4 BSPT	⚠ W5108H-50FM
	10xD	51.00 - 56.99	570.00	624.61	704.60	80.00	50.00	1/4 BSPT	⚠ W5110H-50FM
i	3xD	2.008 - 2.244	6-3/8	8-7/8	13-3/8	4-1/2	2	1/4 NPT	W5103H-200F
	5xD	2.008 - 2.244	11-1/8	13-3/8	17-7/8	4-1/2	2	1/4 NPT	W5105H-200F
	8xD	2.008 - 2.244	17-7/8	20-3/32	24-19/32	4-1/2	2	1/4 NPT	⚠ W5108H-200F
	10xD	2.008 - 2.244	22-3/8	24-19/32	29-3/32	4-1/2	2	1/4 NPT	⚠ W5110H-200F

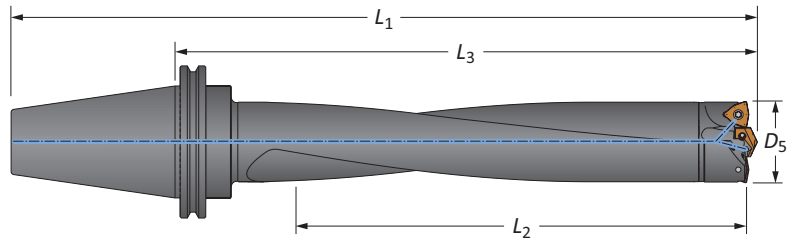

CV50 Shank

	Length	D ₅		Body			Shank	Part No.
		mm	inch	L ₂	L ₃	L ₁		
i	3xD	51.00 - 56.99	2.008 - 2.244	6-3/8	9-47/64	13-47/64	CV50	W5103H-CV50
	5xD	51.00 - 56.99	2.008 - 2.244	11-1/4	14-7/32	18-7/32	CV50	W5105H-CV50
	8xD	51.00 - 56.99	2.008 - 2.244	17-7/8	20-61/64	24-61/64	CV50	⚠ W5108H-CV50
	10xD	51.00 - 56.99	2.008 - 2.244	22-3/8	25-7/16	29-7/16	CV50	⚠ W5110H-CV50

Connection Accessories

Mounting Screw	Mounting Screw Driver	Admissible Tightening Torque*
75020-IP20-1	8IP-20	678 N-cm (60 in-lb)

*Tightening torques are calculated with a friction coefficient of $\mu = 0.14$ and develop 90% of ultimate yield strength

⚠ WARNING Refer to Speed and Feed charts for recommended adjustments to speeds and feeds. Refer to page A50: 30 for deep hole drilling guidelines in this section of the catalogue. Visit www.alliedmachine.com/DeepHoleGuidelines for the most up-to-date information and procedures. Factory technical assistance is available for your specific applications through our Application Engineering Team.
email: engineering.eu@alliedmachine.com

m = Metric (mm)
i = Imperial (in)

Mounting screws sold in multiples of 4

57

 DRILLING | APX™ Drill: Deep Hole / Large Diameter Replaceable Insert Drilling System

APX Drill Heads

57 Series | Diameter Range: 57.00 mm - 62.99 mm (2.244" - 2.480")

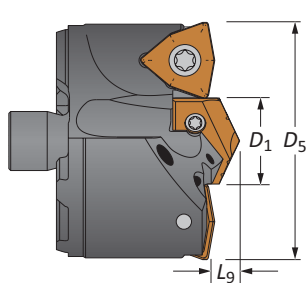

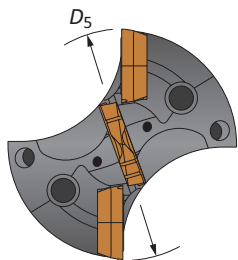
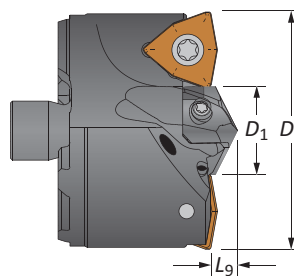

T-A® Head

GEN3SYS® XT Pro Head

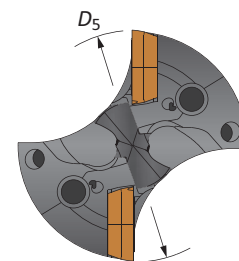







Heads

Head					T-A Head				GEN3SYS XT Pro Head				
D_5 metric	D_5 inch	D_5 fractional	D_1	L_9	Part No.	Pilot Series			Part No.	Pilot Series		IC Insert Size	
												metric	inch
57.00	2.244	-	23.00	9.92	V5701D-57	1	TA#1-23.00	1C11H-23-TC	V5722D-57	22	XT#22-23.00	14.29	9/16
57.15	2.250	2-1/4	23.00	9.92	V5701D-0208	1	TA#1-23.00	1C11H-23-TC	V5722D-0208	22	XT#22-23.00	14.29	9/16
57.94	2.281	2-9/32	23.00	9.92	V5701D-0209	1	TA#1-23.00	1C11H-23-TC	V5722D-0209	22	XT#22-23.00	14.29	9/16
58.00	2.284	-	23.00	9.92	V5701D-58	1	TA#1-23.00	1C11H-23-TC	V5722D-58	22	XT#22-23.00	14.29	9/16
58.74	2.313	2-5/16	23.00	9.92	V5701D-0210	1	TA#1-23.00	1C11H-23-TC	V5722D-0210	22	XT#22-23.00	14.29	9/16
59.00	2.323	-	24.00	9.92	V5701D-59	1	TA#1-24.00	1C11H-24-TC	V5722D-59	22	XT#22-23.80	14.29	9/16
59.53	2.344	2-11/32	24.00	9.92	V5701D-0211	1	TA#1-24.00	1C11H-24-TC	V5722D-0211	22	XT#22-23.80	14.29	9/16
60.00	2.362	-	24.00	9.92	V5701D-60	1	TA#1-24.00	1C11H-24-TC	V5722D-60	22	XT#22-23.80	14.29	9/16
60.33	2.375	2-3/8	24.00	9.92	V5701D-0212	1	TA#1-24.00	1C11H-24-TC	V5722D-0212	22	XT#22-23.80	14.29	9/16
61.00	2.402	-	25.50	9.92	V5702D-61	2	TA#2-25.50	1C12H-25.5-TC	V5724D-61	24	XT#24-25.50	14.29	9/16
61.12	2.406	2-13/32	25.50	9.92	V5702D-0213	2	TA#2-25.50	1C12H-25.5-TC	V5724D-0213	24	XT#24-25.50	14.29	9/16
61.91	2.438	2-7/16	25.50	9.92	V5702D-0214	2	TA#2-25.50	1C12H-25.5-TC	V5724D-0214	24	XT#24-25.50	14.29	9/16
62.00	2.441	-	27.00	9.92	V5702D-62	2	TA#2-27.00	1C12H-27-TC	V5726D-62	26	XT#26-27.00	14.29	9/16
62.71	2.469	2-15/32	27.00	9.92	V5702D-0215	2	TA#2-27.00	1C12H-27-TC	V5726D-0215	26	XT#26-27.00	14.29	9/16

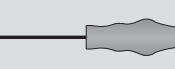

#Denotes ISO material/geometry (P= steel, K= cast iron, N= non-ferrous)

IC Inserts



Coating	Size		Grade	Geometry		Part No.			Admissible Tightening Torque*
	metric	inch							
AM300®	14.29	9/16	P35 (C5)	Standard		OP-090608-PW	75014-IP20-1	8IP-20	1370 N-cm (121.0 in-lbs)
AM300®	14.29	9/16	K35 (C1)	Standard		OP-090608-1PW	75014-IP20-1	8IP-20	1370 N-cm (121.0 in-lbs)
AM300®	14.29	9/16	K25 (C2)	Standard		OP-090608-2PW	75014-IP20-1	8IP-20	1370 N-cm (121.0 in-lbs)
AM300®	14.29	9/16	P35 (C5)	High Rake		OP-090608-PWHR	75014-IP20-1	8IP-20	1370 N-cm (121.0 in-lbs)

*Tightening torques are calculated with a friction coefficient of $\mu = 0.14$ and develop 90% of ultimate yield strength

Pilot Accessories

Pilot Style	Series			Admissible Tightening Torque*
T-A	1	7375-IP9-1	8IP-9	305 N-cm (27.0 in-lbs)
T-A	2	7495-IP15-1	8IP-15	690 N-cm (61.0 in-lbs)
GEN3SYS	22	739-IP9-1	8IP-9	305 N-cm (27.0 in-lbs)
GEN3SYS	24	739-IP9-1	8IP-9	305 N-cm (27.0 in-lbs)
GEN3SYS	26	7495-IP15-1	8IP-15	690 N-cm (61.0 in-lbs)

*Tightening torques are calculated with a friction coefficient of $\mu = 0.14$ and develop 90% of ultimate yield strength

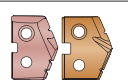
A50: 28 - 29  A50: 2 - 5  Section A20  Section A25 & A30 

Non-stocked diameters are also available. Follow the examples shown below.

Metric	38 series, T-A (1 series), 42.15 mm	Part No. = V3801D-42.15
Inch	38 series, T-A (1 series), 1.6790"	Part No. = V3801D-1.6790

IC inserts sold in multiples of 2 | Insert screws sold in multiples of 10

A50: 14

www.alliedmachine.com | +44 (0) 1384 400 900 | enquiries.eu@alliedmachine.com

A DRILLING

B BORING

C REAMING

D BURNISHING

E THREADING

X SPECIALS

APX Drill Holders

57 Series | Diameter Range: 57.00 mm - 62.99 mm (2.244" - 2.480")

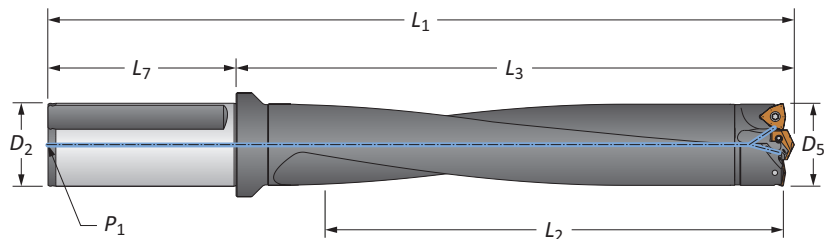

Straight Shank

	Length	D ₅	Body			Shank			Part No.
			L ₂	L ₃	L ₁	L ₇	D ₂	P ₁	
m	3xD	57.00 - 62.99	179.91	242.70	322.71	80.00	50.00	1/4 BSPT	W5703H-50FM
	5xD	57.00 - 62.99	315.01	368.60	448.59	80.00	50.00	1/4 BSPT	W5705H-50FM
	8xD	57.00 - 62.99	503.90	557.81	637.81	80.00	50.00	1/4 BSPT	⚠ W5708H-50FM
	10xD	57.00 - 62.99	626.90	683.79	763.80	80.00	50.00	1/4 BSPT	⚠ W5710H-50FM
i	3xD	2.244 - 2.480	7-1/8	9-35/64	14-1/16	4-1/2	2	1/4 NPT	W5703H-200F
	5xD	2.244 - 2.480	12-3/8	14-33/64	19-1/64	4-1/2	2	1/4 NPT	W5705H-200F
	8xD	2.244 - 2.480	19-3/4	21-31/32	26-15/32	4-1/2	2	1/4 NPT	⚠ W5708H-200F
	10xD	2.244 - 2.480	24-3/4	26-59/64	31-27/64	4-1/2	2	1/4 NPT	⚠ W5710H-200F

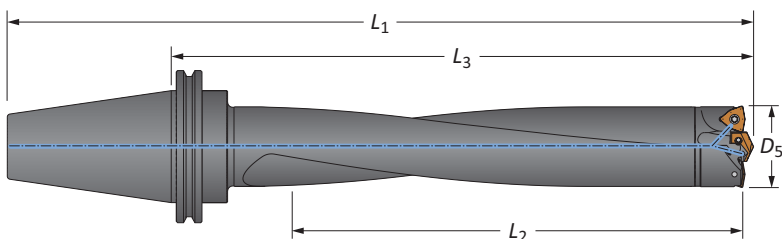

CV50 Shank

	Length	D ₅		Body			Shank	Part No.
		mm	inch	L ₂	L ₃	L ₁		
i	3xD	57.00 - 62.99	2.244 - 2.480	7-1/8	10-17/32	14-17/32	CV50	W5703H-CV50
	5xD	57.00 - 62.99	2.244 - 2.480	12-3/8	15-31/64	19-31/64	CV50	W5705H-CV50
	8xD	57.00 - 62.99	2.244 - 2.480	19-7/8	22-15/16	26-15/16	CV50	⚠ W5708H-CV50
	10xD	57.00 - 62.99	2.244 - 2.480	24-3/4	27-57/64	31-57/64	CV50	⚠ W5710H-CV50

Connection Accessories

Mounting Screw	Mounting Screw Driver	Admissible Tightening Torque*
75020-IP20-1	8IP-20	678 N-cm (60 in-lb)

*Tightening torques are calculated with a friction coefficient of $\mu = 0.14$ and develop 90% of ultimate yield strength

⚠ WARNING Refer to Speed and Feed charts for recommended adjustments to speeds and feeds. Refer to page A50: 30 for deep hole drilling guidelines in this section of the catalogue. Visit www.alliedmachine.com/DeepHoleGuidelines for the most up-to-date information and procedures. Factory technical assistance is available for your specific applications through our Application Engineering Team.
email: engineering.eu@alliedmachine.com

m = Metric (mm)
i = Imperial (in)

Mounting screws sold in multiples of 4

APX Drill Heads

63 Series | Diameter Range: 63.00 mm - 69.99 mm (2.480" - 2.756")

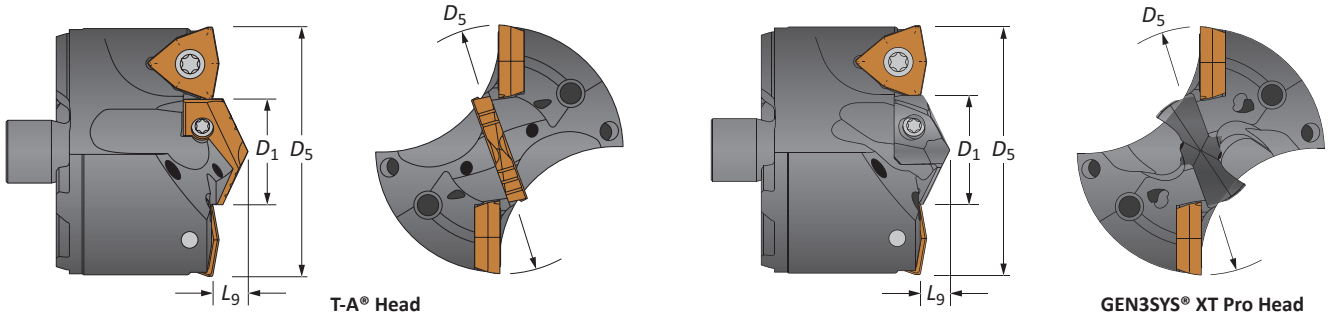

Heads

Head					T-A Head				GEN3SYS XT Pro Head			IC Insert Size	
D ₅ metric	D ₅ inch	D ₅ fractional	D ₁	L ₉	Part No.	Pilot Series	T-A Pro Insert	T-A (-TC) Insert	Part No.	Pilot Series	Pilot Insert	metric	inch
63.00	2.480	-	28.50	11.11	V6302D-63	2	TA#2-28.50	1C12H-28.5-TC	V6326D-63	26	XT#26-28.50	14.29	9/16
63.50	2.500	2-1/2	28.50	11.11	V6302D-0216	2	TA#2-28.50	1C12H-28.5-TC	V6326D-0216	26	XT#26-28.50	14.29	9/16
64.00	2.520	-	28.50	11.11	V6302D-64	2	TA#2-28.50	1C12H-28.5-TC	V6326D-64	26	XT#26-28.50	14.29	9/16
64.29	2.531	2-17/32	28.50	11.11	V6302D-0217	2	TA#2-28.50	1C12H-28.5-TC	V6326D-0217	26	XT#26-28.50	14.29	9/16
65.00	2.559	-	28.50	11.11	V6302D-65	2	TA#2-28.50	1C12H-28.5-TC	V6326D-65	26	XT#26-28.50	14.29	9/16
65.09	2.563	2-9/16	31.00	11.11	V6302D-0218	2	TA#2-31.00	1C12H-31-TC	V6329D-0218	29	XT#29-31.00	14.29	9/16
65.88	2.594	2-19/32	31.00	11.11	V6302D-0219	2	TA#2-31.00	1C12H-31-TC	V6329D-0219	29	XT#29-31.00	14.29	9/16
66.00	2.598	-	31.00	11.11	V6302D-66	2	TA#2-31.00	1C12H-31-TC	V6329D-66	29	XT#29-31.00	14.29	9/16
66.68	2.625	2-5/8	31.00	11.11	V6302D-0220	2	TA#2-31.00	1C12H-31-TC	V6329D-0220	29	XT#29-31.00	14.29	9/16
67.00	2.638	-	32.00	11.11	V6302D-67	2	TA#2-32.00	1C12H-32-TC	V6329D-67	29	XT#29-31.80	14.29	9/16
67.47	2.656	2-21/32	32.00	11.11	V6302D-0221	2	TA#2-32.00	1C12H-32-TC	V6329D-0221	29	XT#29-31.80	14.29	9/16
68.00	2.677	-	32.00	11.11	V6302D-68	2	TA#2-32.00	1C12H-32-TC	V6329D-68	29	XT#29-31.80	14.29	9/16
68.26	2.688	2-11/16	32.00	11.11	V6302D-0222	2	TA#2-32.00	1C12H-32-TC	V6329D-0222	29	XT#29-31.80	14.29	9/16
69.00	2.717	-	34.00	11.11	V6302D-69	2	TA#2-34.00	1C12H-34-TC	V6332D-69	32	XT#32-34.00	14.29	9/16
69.06	2.719	2-23/32	34.00	11.11	V6302D-0223	2	TA#2-34.00	1C12H-34-TC	V6332D-0223	32	XT#32-34.00	14.29	9/16
69.85	2.750	2-3/4	34.00	11.11	V6302D-0224	2	TA#2-34.00	1C12H-34-TC	V6332D-0224	32	XT#32-34.00	14.29	9/16

#Denotes ISO material/geometry (P= steel, K= cast iron, N= non-ferrous)

IC Inserts

Coating	Size		Grade	Geometry	Part No.	Insert Screw	Insert Driver	Admissible Tightening Torque*
	metric	inch						
AM300®	14.29	9/16	P35 (C5)	Standard	OP-090608-PW	75014-IP20-1	8IP-20	1370 N-cm (121.0 in-lbs)
AM300®	14.29	9/16	K35 (C1)	Standard	OP-090608-1PW	75014-IP20-1	8IP-20	1370 N-cm (121.0 in-lbs)
AM300®	14.29	9/16	K25 (C2)	Standard	OP-090608-2PW	75014-IP20-1	8IP-20	1370 N-cm (121.0 in-lbs)
AM300®	14.29	9/16	P35 (C5)	High Rake	OP-090608-PWHR	75014-IP20-1	8IP-20	1370 N-cm (121.0 in-lbs)

*Tightening torques are calculated with a friction coefficient of $\mu = 0.14$ and develop 90% of ultimate yield strength

Pilot Accessories

Pilot Style	Series	Insert Screws	Insert Driver	Admissible Tightening Torque*
T-A	2	7495-IP15-1	8IP-15	690 N-cm (61.0 in-lbs)
GEN3SYS	26	7495-IP15-1	8IP-15	690 N-cm (61.0 in-lbs)
GEN3SYS	29	7495-IP15-1	8IP-15	690 N-cm (61.0 in-lbs)
GEN3SYS	32	7495-IP15-1	8IP-15	690 N-cm (61.0 in-lbs)

*Tightening torques are calculated with a friction coefficient of $\mu = 0.14$ and develop 90% of ultimate yield strength

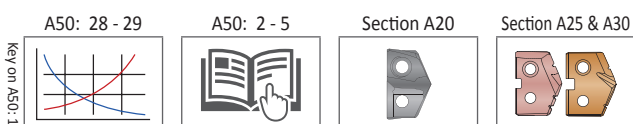

Non-stocked diameters are also available. Follow the examples shown below.

Metric	38 series, T-A (1 series), 42.15 mm	Part No. = V3801D-42.15
Inch	38 series, T-A (1 series), 1.6790"	Part No. = V3801D-1.6790

IC inserts sold in multiples of 2 | Insert screws sold in multiples of 10

APX Drill Holders

63 Series | Diameter Range: 63.00 mm - 69.99 mm (2.480" - 2.756")

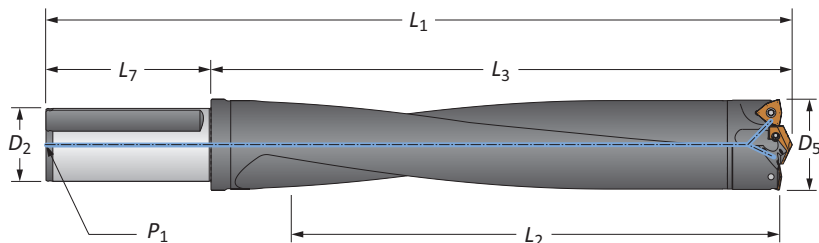

Straight Shank

	Length	Body				Shank			Part No.
		D ₅	L ₂	L ₃	L ₁	L ₇	D ₂	P ₁	
m	3xD	63.00 - 69.99	200.81	262.61	342.60	80.00	50.00	1/4 BSPT	W6303H-50FM
	5xD	63.00 - 69.99	350.00	402.59	482.60	80.00	50.00	1/4 BSPT	W6305H-50FM
	8xD	63.00 - 69.99	559.99	612.60	692.61	80.00	50.00	1/4 BSPT	⚠ W6308H-50FM
	10xD	63.00 - 69.99	688.29	740.89	820.90	80.00	50.00	1/4 BSPT	⚠ W6310H-50FM
i	3xD	2.480 - 2.756	7-7/8	10-11/32	14-27/32	4-1/2	2	1/4 NPT	W6303H-200F
	5xD	2.480 - 2.756	13-3/4	15-27/32	20-11/32	4-1/2	2	1/4 NPT	W6305H-200F
	8xD	2.480 - 2.756	22-1/8	24-1/8	28-5/8	4-1/2	2	1/4 NPT	⚠ W6308H-200F
	10xD	2.480 - 2.756	27-1/8	29-11/64	33-43/64	4-1/2	2	1/4 NPT	⚠ W6310H-200F

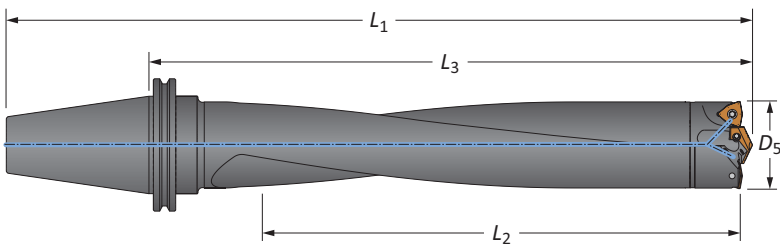

CV50 Shank

	Length	D ₅		Body			Shank	Part No.
		mm	inch	L ₂	L ₃	L ₁		
i	3xD	63.00 - 69.99	2.480 - 2.756	7-7/8	11-7/16	15-7/16	CV50	W6303H-CV50
	5xD	63.00 - 69.99	2.480 - 2.756	13-3/4	16-15/16	20-15/16	CV50	W6305H-CV50
	8xD	63.00 - 69.99	2.480 - 2.756	22	25-13/64	29-13/64	CV50	⚠ W6308H-CV50
	10xD	63.00 - 69.99	2.480 - 2.756	26-1/2	29-43/64	33-43/64	CV50	⚠ W6310H-CV50

Connection Accessories

Mounting Screw	Mounting Screw Driver	Admissible Tightening Torque*
75020-IP20-1	8IP-20	678 N-cm (60 in-lb)

*Tightening torques are calculated with a friction coefficient of $\mu = 0.14$ and develop 90% of ultimate yield strength

⚠ WARNING Refer to Speed and Feed charts for recommended adjustments to speeds and feeds. Refer to page A50: 30 for deep hole drilling guidelines in this section of the catalogue. Visit www.alliedmachine.com/DeepHoleGuidelines for the most up-to-date information and procedures. Factory technical assistance is available for your specific applications through our Application Engineering Team.
email: engineering.eu@alliedmachine.com

m = Metric (mm)
i = Imperial (in)

Mounting screws sold in multiples of 4



A DRILLING
B BORING
C REAMING
D BURNISHING
E THREADING
X SPECIALS

APX Drill Heads

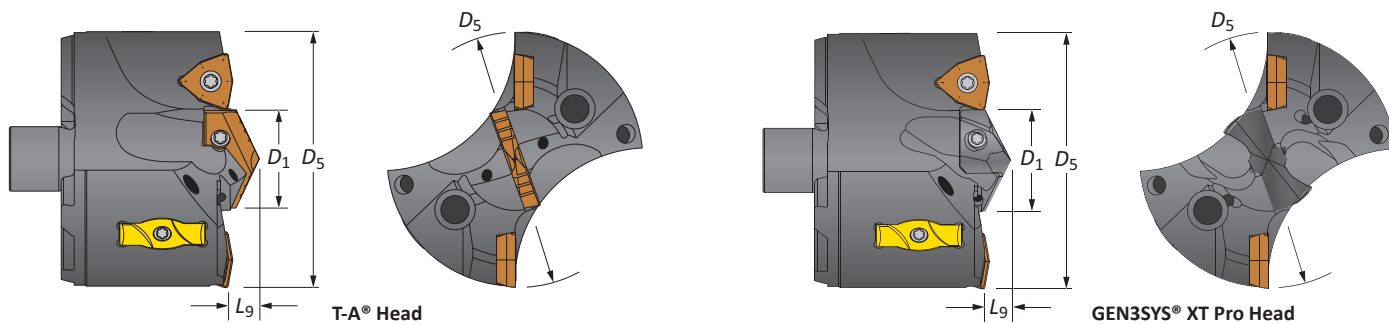
70 Series | Diameter Range: 70.00 mm - 75.99 mm (2.756" - 2.992")





Heads

Head					T-A Head				GEN3SYS XT Pro Head				
D_5 metric	D_5 inch	D_5 fractional	D_1	L_9	Part No.	Pilot Series			Part No.	Pilot Series		IC Insert Size	
												metric	inch
70.00	2.756	-	31.00	9.92	V7002S-70	2	TA#2-31.00	1C12H-31-TC	V7029S-70	29	XT#29-31.00	9.53	3/8
71.44	2.813	2-13/16	31.00	9.92	V7002S-0226	2	TA#2-31.00	1C12H-31-TC	V7029S-0226	29	XT#29-31.00	9.53	3/8
72.00	2.835	-	31.00	9.92	V7002S-72	2	TA#2-31.00	1C12H-31-TC	V7029S-72	29	XT#29-31.00	9.53	3/8
73.03	2.875	2-7/8	31.00	9.92	V7002S-0228	2	TA#2-31.00	1C12H-31-TC	V7029S-0228	29	XT#29-31.00	9.53	3/8
74.00	2.913	-	31.00	9.92	V7002S-74	2	TA#2-31.00	1C12H-31-TC	V7029S-74	29	XT#29-31.00	9.53	3/8
74.61	2.938	2-15/16	31.00	9.92	V7002S-0230	2	TA#2-31.00	1C12H-31-TC	V7029S-0230	29	XT#29-31.00	9.53	3/8



#Denotes ISO material/geometry (P= steel, K= cast iron, N= non-ferrous)

IC Inserts

Coating	Size		Grade	Geometry	 Part No.	 Insert Screw	 Insert Driver	Admissible Tightening Torque*
	metric	inch						
AM300®	9.53	3/8	P35 (C5)	Standard	OP-060408-PW	73595-IP15-1	8IP-15	465 N-cm (41.0 in-lbs)
AM300®	9.53	3/8	K35 (C1)	Standard	OP-060408-1PW	73595-IP15-1	8IP-15	465 N-cm (41.0 in-lbs)
AM300®	9.53	3/8	K25 (C2)	Standard	OP-060408-2PW	73595-IP15-1	8IP-15	465 N-cm (41.0 in-lbs)
AM300®	9.53	3/8	P35 (C5)	High Rake	OP-060408-PWHR	73595-IP15-1	8IP-15	465 N-cm (41.0 in-lbs)



*Tightening torques are calculated with a friction coefficient of $\mu = 0.14$ and develop 90% of ultimate yield strength

Wear Pads

 Part No.	 Wear Pad Screw	 Wear Pad Driver	Admissible Tightening Torque*
WP7095	7358-IP10-1	8IP-10	300 N-cm (27.0 in-lbs)

*Tightening torques are calculated with a friction coefficient of $\mu = 0.14$ and develop 90% of ultimate yield strength

Pilot Accessories

Pilot Style	Series	 Insert Screws	 Insert Driver	Admissible Tightening Torque*
T-A	2	7495-IP15-1	8IP-15	690 N-cm (61.0 in-lbs)
GEN3SYS	29	7495-IP15-1	8IP-15	690 N-cm (61.0 in-lbs)

*Tightening torques are calculated with a friction coefficient of $\mu = 0.14$ and develop 90% of ultimate yield strength

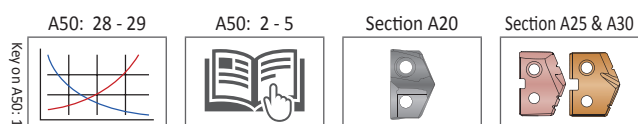

Non-stocked diameters are also available. Follow the examples shown below.

Metric	38 series, T-A (1 series), 42.15 mm	Part No. = V3801D-42.15
Inch	38 series, T-A (1 series), 1.6790"	Part No. = V3801D-1.6790

Wear pads sold in multiples of 2 | Wear pad screws sold in multiples of 4
IC inserts sold in multiples of 2 | Insert screws sold in multiples of 10

APX Drill Holders

70 Series | Diameter Range: 70.00 mm - 75.99 mm (2.756" - 2.992")

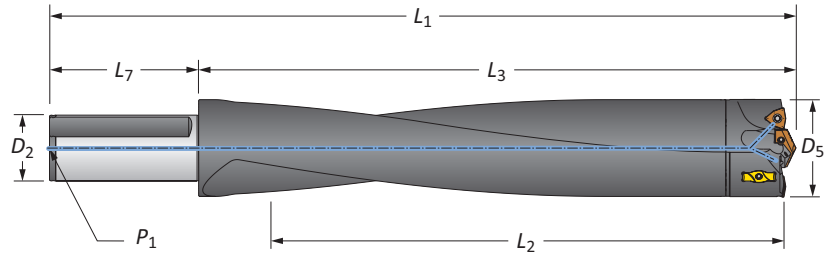

Straight Shank

	Length	Body				Shank			Part No.
		D ₅	L ₂	L ₃	L ₁	L ₇	D ₂	P ₁	
m	3xD	70.00 - 75.99	218.80	269.01	349.00	80.00	50.00	1/4 BSPT	W7003H-50FM
	5xD	70.00 - 75.99	380.01	421.11	501.09	80.00	50.00	1/4 BSPT	W7005H-50FM
	8xD	70.00 - 75.99	608.00	649.00	729.01	80.00	50.00	1/4 BSPT	⚠ W7008H-50FM
	10xD	70.00 - 75.99	709.40	750.29	830.30	80.00	50.00	1/4 BSPT	⚠ W7010H-50FM
i	3xD	2.756 - 2.992	8-3/4	10-19/32	15-3/32	4-1/2	2	1/4 NPT	W7003H-200F
	5xD	2.756 - 2.992	14-7/8	16-37/64	21-5/64	4-1/2	2	1/4 NPT	W7005H-200F
	8xD	2.756 - 2.992	23-7/8	25-35/64	30-3/64	4-1/2	2	1/4 NPT	⚠ W7008H-200F
	10xD	2.756 - 2.992	27-7/8	29-35/64	34-3/64	4-1/2	2	1/4 NPT	⚠ W7010H-200F

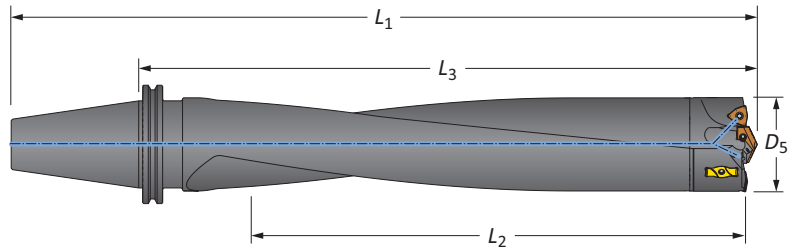

CV50 Shank

	Length	D ₅		Body			Shank	Part No.
		mm	inch	L ₂	L ₃	L ₁		
i	3xD	70.00 - 75.99	2.756 - 2.992	8-3/4	12-7/32	16-7/32	CV50	W7003H-CV50
	5xD	70.00 - 75.99	2.756 - 2.992	14-7/8	18-13/64	22-13/64	CV50	W7005H-CV50
	8xD	70.00 - 75.99	2.756 - 2.992	23-7/8	27-5/32	31-5/32	CV50	⚠ W7008H-CV50
	10xD	70.00 - 75.99	2.756 - 2.992	26-3/4	29-61/64	33-61/64	CV50	⚠ W7010H-CV50

Connection Accessories

Mounting Screw	Mounting Screw Bit	Admissible Tightening Torque*
78027-IP30-1	8IP-30B	2825 N-cm (250 in-lb)

*Tightening torques are calculated with a friction coefficient of $\mu = 0.14$ and develop 90% of ultimate yield strength

⚠ WARNING Refer to Speed and Feed charts for recommended adjustments to speeds and feeds. Refer to page A50: 30 for deep hole drilling guidelines in this section of the catalogue. Visit www.alliedmachine.com/DeepHoleGuidelines for the most up-to-date information and procedures. Factory technical assistance is available for your specific applications through our Application Engineering Team.
email: engineering.eu@alliedmachine.com

m = Metric (mm)
i = Imperial (in)

Mounting screws sold in multiples of 4

APX Drill Heads

76 Series | Diameter Range: 76.00 mm - 82.99 mm (2.992" - 3.268")

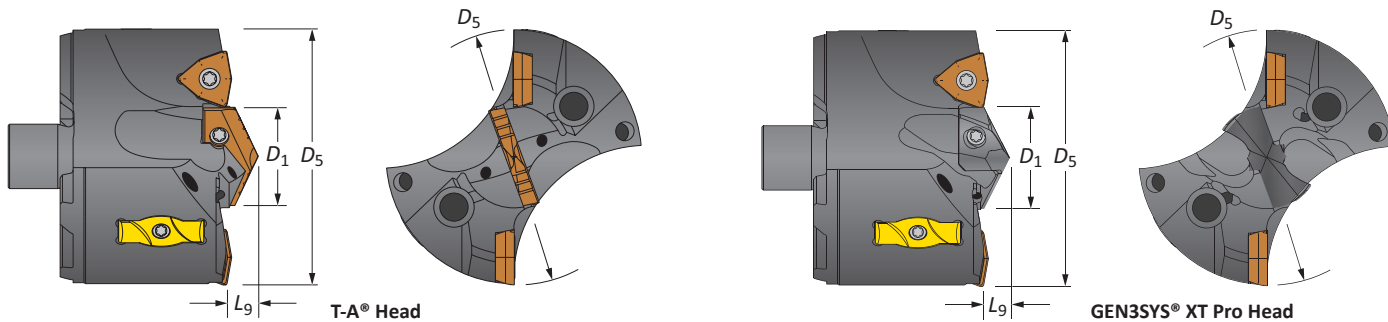

Heads

Head					T-A Head				GEN3SYS XT Pro Head				
D ₅ metric	D ₅ inch	D ₅ fractional	D ₁	L ₉	Part No.	Pilot Series	T-A Pro Insert	T-A (-TC) Insert	Part No.	Pilot Series	Pilot Insert	IC Insert Size metric	IC Insert Size inch
76.00	2.992	-	31.00	10.32	V7602S-76	2	TA#2-31.00	1C12H-31-TC	V7629S-76	29	XT#29-31.00	12.70	1/2
76.20	3.000	3	31.00	10.32	V7602S-0300	2	TA#2-31.00	1C12H-31-TC	V7629S-0300	29	XT#29-31.00	12.70	1/2
77.79	3.063	3-1/16	31.00	10.32	V7602S-0302	2	TA#2-31.00	1C12H-31-TC	V7629S-0302	29	XT#29-31.00	12.70	1/2
78.00	3.071	-	31.00	10.32	V7602S-78	2	TA#2-31.00	1C12H-31-TC	V7629S-78	29	XT#29-31.00	12.70	1/2
79.38	3.125	3-1/8	31.00	10.32	V7602S-0304	2	TA#2-31.00	1C12H-31-TC	V7629S-0304	29	XT#29-31.00	12.70	1/2
80.00	3.150	-	31.00	10.32	V7602S-80	2	TA#2-31.00	1C12H-31-TC	V7629S-80	29	XT#29-31.00	12.70	1/2
80.96	3.188	3-3/16	31.00	10.32	V7602S-0306	2	TA#2-31.00	1C12H-31-TC	V7629S-0306	29	XT#29-31.00	12.70	1/2
82.00	3.228	-	31.00	10.32	V7602S-82	2	TA#2-31.00	1C12H-31-TC	V7629S-82	29	XT#29-31.00	12.70	1/2
82.55	3.250	3-1/4	31.00	10.32	V7602S-0308	2	TA#2-31.00	1C12H-31-TC	V7629S-0308	29	XT#29-31.00	12.70	1/2

#Denotes ISO material/geometry (P= steel, K= cast iron, N= non-ferrous)

IC Inserts

Coating	Size		Grade	Geometry	Part No.	Insert Screw	Insert Driver	Admissible Tightening Torque*
	metric	inch						
AM300®	12.70	1/2	P35 (C5)	Standard	OP-080508-PW	74012-IP15-1	8IP-15	690 N-cm (61.0 in-lbs)
AM300®	12.70	1/2	K35 (C1)	Standard	OP-080508-1PW	74012-IP15-1	8IP-15	690 N-cm (61.0 in-lbs)
AM300®	12.70	1/2	K25 (C2)	Standard	OP-080508-2PW	74012-IP15-1	8IP-15	690 N-cm (61.0 in-lbs)
AM300®	12.70	1/2	P35 (C5)	High Rake	OP-080508-PWHR	74012-IP15-1	8IP-15	690 N-cm (61.0 in-lbs)

*Tightening torques are calculated with a friction coefficient of $\mu = 0.14$ and develop 90% of ultimate yield strength

Wear Pads

Part No.	Wear Pad Screw	Wear Pad Driver	Admissible Tightening Torque*
WP7095	7358-IP10-1	8IP-10	300 N-cm (27.0 in-lbs)

*Tightening torques are calculated with a friction coefficient of $\mu = 0.14$ and develop 90% of ultimate yield strength

Pilot Accessories

Pilot Style	Series	Insert Screws	Insert Driver	Admissible Tightening Torque*
T-A	2	7495-IP15-1	8IP-15	690 N-cm (61.0 in-lbs)
GEN3SYS	29	7495-IP15-1	8IP-15	690 N-cm (61.0 in-lbs)

*Tightening torques are calculated with a friction coefficient of $\mu = 0.14$ and develop 90% of ultimate yield strength

A50: 28 - 29 | A50: 2 - 5 | Section A20 | Section A25 & A30

Non-stocked diameters are also available. Follow the examples shown below.

Metric	38 series, T-A (1 series), 42.15 mm	Part No. = V3801D-42.15
Inch	38 series, T-A (1 series), 1.6790"	Part No. = V3801D-1.6790

Wear pads sold in multiples of 2 | Wear pad screws sold in multiples of 4
IC inserts sold in multiples of 2 | Insert screws sold in multiples of 10

APX Drill Holders

76 Series | Diameter Range: 76.00 mm - 82.99 mm (2.992" - 3.268")

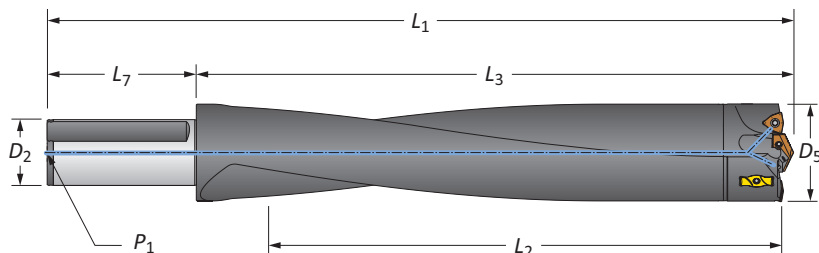

Straight Shank

	Length	D ₅	Body			Shank			Part No.
			L ₂	L ₃	L ₁	L ₇	D ₂	P ₁	
m	3xD	76.00 - 82.99	240.00	292.40	372.39	80.00	50.00	1/4 BSPT	W7603H-50FM
	5xD	76.00 - 82.99	415.01	421.11	501.09	80.00	50.00	1/4 BSPT	W7605H-50FM
	8xD	76.00 - 82.99	664.01	648.69	728.70	80.00	50.00	1/4 BSPT	⚠ W7608H-50FM
i	3xD	2.992 - 3.268	9-1/2	11-33/64	16-1/64	4-1/2	2	1/4 NPT	W7603H-200F
	5xD	2.992 - 3.268	16-3/8	18-3/64	22-35/64	4-1/2	2	1/4 NPT	W7605H-200F
	8xD	2.992 - 3.268	26-1/8	27-27/32	32-11/32	4-1/2	2	1/4 NPT	⚠ W7608H-200F

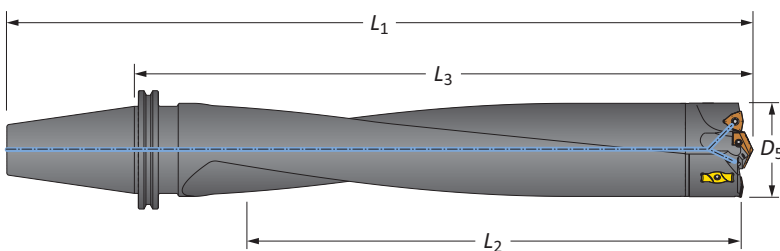

CV50 Shank

	Length	D ₅		Body			Shank	Part No.
		mm	inch	L ₂	L ₃	L ₁		
i	3xD	76.00 - 82.99	2.992 - 3.268	9-1/2	12-57/64	16-57/64	CV50	W7603H-CV50
	5xD	76.00 - 82.99	2.992 - 3.268	16-3/8	19-27/64	23-27/64	CV50	W7605H-CV50
	8xD	76.00 - 82.99	2.992 - 3.268	26-1/8	29-7/32	33-7/32	CV50	⚠ W7608H-CV50

Connection Accessories

Mounting Screw	Mounting Screw Bit	Admissible Tightening Torque*
78027-IP30-1	8IP-30B	2825 N-cm (250 in-lb)

*Tightening torques are calculated with a friction coefficient of $\mu = 0.14$ and develop 90% of ultimate yield strength

⚠ WARNING Refer to Speed and Feed charts for recommended adjustments to speeds and feeds. Refer to page A50: 30 for deep hole drilling guidelines in this section of the catalogue. Visit www.alliedmachine.com/DeepHoleGuidelines for the most up-to-date information and procedures. Factory technical assistance is available for your specific applications through our Application Engineering Team.
email: engineering.eu@alliedmachine.com

m = Metric (mm)
i = Imperial (in)

Mounting screws sold in multiples of 4

APX Drill Heads

83 Series | Diameter Range: 83.00 mm - 88.99 mm (3.268" - 3.504")

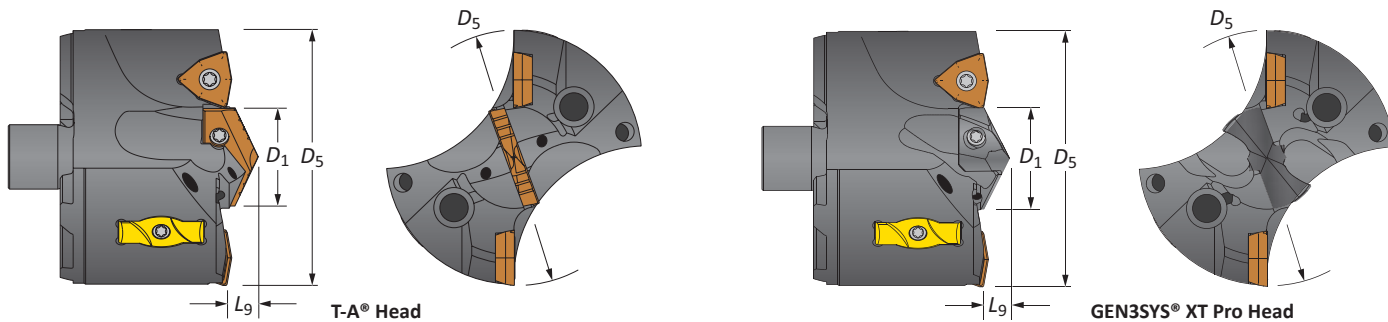

Heads

Head					T-A Head				GEN3SYS XT Pro Head				
D ₅ metric	D ₅ inch	D ₅ fractional	D ₁	L ₉	Part No.	Pilot Series	T-A Pro Insert	T-A (-TC) Insert	Part No.	Pilot Series	Pilot Insert	IC Insert Size	
												metric	inch
84.00	3.307	-	32.00	10.72	V8302S-84	2	TA#2-35.00	1C12H-35-TC	V8332S-84	32	XT#32-35.00	12.70	1/2
84.14	3.313	3-5/16	32.00	10.72	V8302S-0310	2	TA#2-35.00	1C12H-35-TC	V8332S-0310	32	XT#32-35.00	12.70	1/2
85.73	3.375	3-3/8	32.00	10.72	V8302S-0312	2	TA#2-35.00	1C12H-35-TC	V8332S-0312	32	XT#32-35.00	12.70	1/2
86.00	3.386	-	32.00	10.72	V8302S-86	2	TA#2-35.00	1C12H-35-TC	V8332S-86	32	XT#32-35.00	12.70	1/2
87.31	3.438	3-7/16	32.00	10.72	V8302S-0314	2	TA#2-35.00	1C12H-35-TC	V8332S-0314	32	XT#32-35.00	12.70	1/2
88.00	3.465	-	32.00	10.72	V8302S-88	2	TA#2-35.00	1C12H-35-TC	V8332S-88	32	XT#32-35.00	12.70	1/2
88.90	3.500	3-1/2	32.00	10.72	V8302S-0316	2	TA#2-35.00	1C12H-35-TC	V8332S-0316	32	XT#32-35.00	12.70	1/2

#Denotes ISO material/geometry (P= steel, K= cast iron, N= non-ferrous)

IC Inserts

Coating	Size		Grade	Geometry	Part No.	Insert Screw	Insert Driver	Admissible Tightening Torque*
	metric	inch						
AM300®	12.70	1/2	P35 (C5)	Standard	OP-080508-PW	74012-IP15-1	8IP-15	690 N-cm (61.0 in-lbs)
AM300®	12.70	1/2	K35 (C1)	Standard	OP-080508-1PW	74012-IP15-1	8IP-15	690 N-cm (61.0 in-lbs)
AM300®	12.70	1/2	K25 (C2)	Standard	OP-080508-2PW	74012-IP15-1	8IP-15	690 N-cm (61.0 in-lbs)
AM300®	12.70	1/2	P35 (C5)	High Rate	OP-080508-PWHR	74012-IP15-1	8IP-15	690 N-cm (61.0 in-lbs)

*Tightening torques are calculated with a friction coefficient of μ = 0.14 and develop 90% of ultimate yield strength

Wear Pads

Part No.	Wear Pad Screw	Wear Pad Driver	Admissible Tightening Torque*
WP7095	7358-IP10-1	8IP-10	300 N-cm (27.0 in-lbs)

*Tightening torques are calculated with a friction coefficient of μ = 0.14 and develop 90% of ultimate yield strength

Pilot Accessories

Pilot Style	Series	Insert Screws	Insert Driver	Admissible Tightening Torque*
T-A	2	7495-IP15-1	8IP-15	690 N-cm (61.0 in-lbs)
GEN3SYS	32	7495-IP15-1	8IP-15	690 N-cm (61.0 in-lbs)

*Tightening torques are calculated with a friction coefficient of μ = 0.14 and develop 90% of ultimate yield strength

Key on ASO: 1

A50: 28 - 29

A50: 2 - 5

Section A20

Section A25 & A30

Non-stocked diameters are also available. Follow the examples shown below.

Metric	38 series, T-A (1 series), 42.15 mm	Part No. = V3801D-42.15
Inch	38 series, T-A (1 series), 1.6790"	Part No. = V3801D-1.6790

Wear pads sold in multiples of 2 | Wear pad screws sold in multiples of 4
IC inserts sold in multiples of 2 | Insert screws sold in multiples of 10

APX Drill Holders

83 Series | Diameter Range: 83.00 mm - 88.99 mm (3.268" - 3.504")

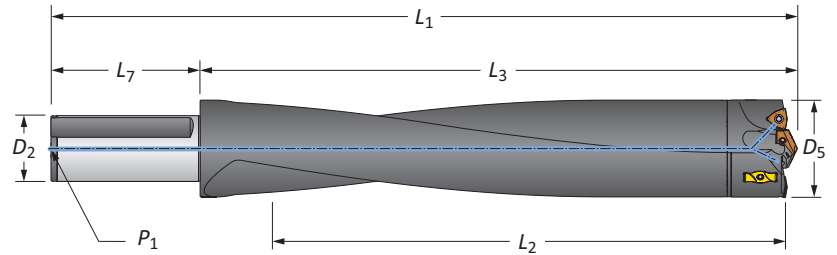

Straight Shank

	Length	D ₅	Body			Shank			Part No.
			L ₂	L ₃	L ₁	L ₇	D ₂	P ₁	
m	3xD	83.00 - 88.99	257.81	312.50	392.61	80.00	50.00	1/4 BSPT	W8303H-50FM
	5xD	83.00 - 88.99	445.00	490.50	570.51	80.00	50.00	1/4 BSPT	W8305H-50FM
	8xD	83.00 - 88.99	704.90	750.29	830.30	80.00	50.00	1/4 BSPT	⚠ W8308H-50FM
i	3xD	3.268 - 3.504	10-1/8	12-5/16	16-13/16	4-1/2	2	1/4 NPT	W8303H-200F
	5xD	3.268 - 3.504	17-1/2	19-5/16	23-13/16	4-1/2	2	1/4 NPT	W8305H-200F
	8xD	3.268 - 3.504	27-3/4	29-35/64	34-3/64	4-1/2	2	1/4 NPT	⚠ W8308H-200F

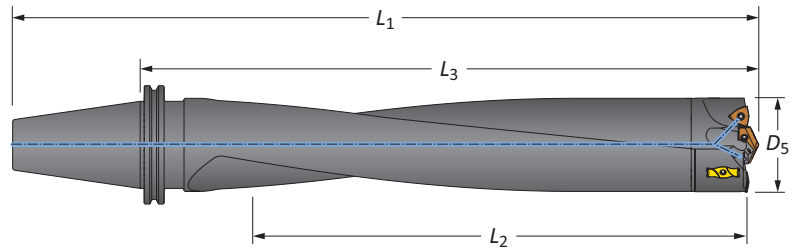

CV50 Shank

	Length	D ₅		Body			Shank	Part No.
		mm	inch	L ₂	L ₃	L ₁		
i	3xD	83.00 - 88.99	3.268 - 3.504	10-1/8	13-11/16	17-11/16	CV50	W8303H-CV50
	5xD	83.00 - 88.99	3.268 - 3.504	17-1/2	20-11/16	24-11/16	CV50	W8305H-CV50
	8xD	83.00 - 88.99	3.268 - 3.504	26-7/8	30-3/64	34-3/64	CV50	⚠ W8308H-CV50

Connection Accessories

Mounting Screw	Mounting Screw Bit	Admissible Tightening Torque*
78027-IP30-1	8IP-30B	2825 N-cm (250 in-lb)

*Tightening torques are calculated with a friction coefficient of $\mu = 0.14$ and develop 90% of ultimate yield strength

⚠ WARNING Refer to Speed and Feed charts for recommended adjustments to speeds and feeds. Refer to page A50: 30 for deep hole drilling guidelines in this section of the catalogue. Visit www.alliedmachine.com/DeepHoleGuidelines for the most up-to-date information and procedures. Factory technical assistance is available for your specific applications through our Application Engineering Team.
email: engineering.eu@alliedmachine.com

m = Metric (mm)
i = Imperial (in)

Mounting screws sold in multiples of 4

89

 DRILLING | APX™ Drill: Deep Hole / Large Diameter Replaceable Insert Drilling System

APX Drill Heads

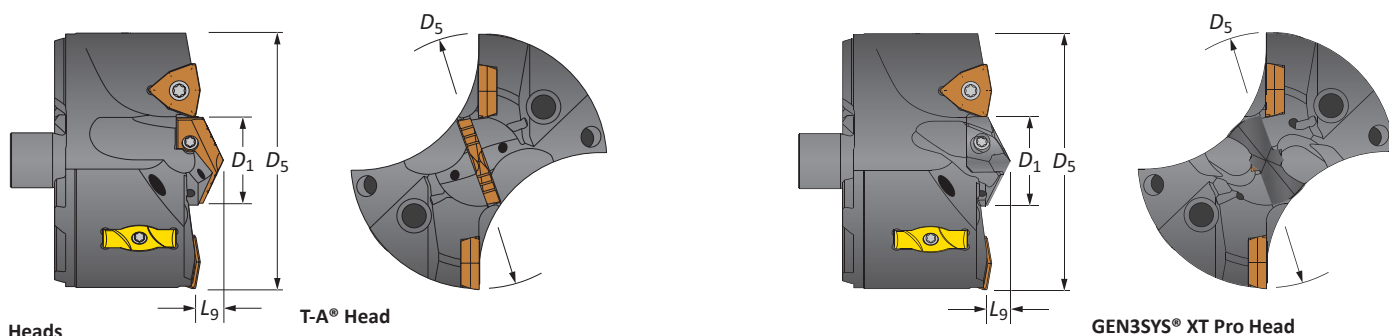

89 Series | Diameter Range: 89.00 mm - 94.99 mm (3.504" - 3.740")



Heads



T-A® Head

GEN3SYS® XT Pro Head

Head					T-A Head				GEN3SYS XT Pro Head				
D_5 metric	D_5 inch	D_5 fractional	D_1	L_9	Part No.	Pilot Series			Part No.	Pilot Series		IC Insert Size	
												metric	inch
90.00	3.543	-	32.00	10.72	V8902S-90	2	TA#2-32.00	1C12H-32-TC	V8929S-90	29	XT#29-31.80	14.29	9/16
90.49	3.563	3-9/16	32.00	10.72	V8902S-0318	2	TA#2-32.00	1C12H-32-TC	V8929S-0318	29	XT#29-31.80	14.29	9/16
92.00	3.622	-	32.00	10.72	V8902S-92	2	TA#2-32.00	1C12H-32-TC	V8929S-92	29	XT#29-31.80	14.29	9/16
92.08	3.625	3-5/8	32.00	10.72	V8902S-0320	2	TA#2-32.00	1C12H-32-TC	V8929S-0320	29	XT#29-31.80	14.29	9/16
93.66	3.688	3-11/16	32.00	10.72	V8902S-0322	2	TA#2-32.00	1C12H-32-TC	V8929S-0322	29	XT#29-31.80	14.29	9/16
94.00	3.701	-	32.00	10.72	V8902S-94	2	TA#2-32.00	1C12H-32-TC	V8929S-94	29	XT#29-31.80	14.29	9/16



#Denotes ISO material/geometry (P= steel, K= cast iron, N= non-ferrous)

IC Inserts

Coating	Size		Grade	Geometry	 Part No.	 Insert Screw	 Insert Driver	Admissible Tightening Torque*
	metric	inch						
AM300®	14.29	9/16	P35 (C5)	Standard	OP-090608-PW	75014-IP20-1	8IP-20	1370 N-cm (121.0 in-lbs)
AM300®	14.29	9/16	K35 (C1)	Standard	OP-090608-1PW	75014-IP20-1	8IP-20	1370 N-cm (121.0 in-lbs)
AM300®	14.29	9/16	K25 (C2)	Standard	OP-090608-2PW	75014-IP20-1	8IP-20	1370 N-cm (121.0 in-lbs)
AM300®	14.29	9/16	P35 (C5)	High Rake	OP-090608-PWHR	75014-IP20-1	8IP-20	1370 N-cm (121.0 in-lbs)



 *Tightening torques are calculated with a friction coefficient of $\mu = 0.14$ and develop 90% of ultimate yield strength

Wear Pads

 Part No.	 Wear Pad Screw	 Wear Pad Driver	Admissible Tightening Torque*
WP7095	7358-IP10-1	8IP-10	300 N-cm (27.0 in-lbs)

 *Tightening torques are calculated with a friction coefficient of $\mu = 0.14$ and develop 90% of ultimate yield strength

Pilot Accessories

Pilot Style	Series	 Insert Screws	 Insert Driver	Admissible Tightening Torque*
T-A	2	7495-IP15-1	8IP-15	690 N-cm (61.0 in-lbs)
GEN3SYS	29	7495-IP15-1	8IP-15	690 N-cm (61.0 in-lbs)

 *Tightening torques are calculated with a friction coefficient of $\mu = 0.14$ and develop 90% of ultimate yield strength

Key on ASO: 1

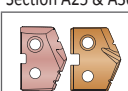
A50: 28 - 29  A50: 2 - 5  Section A20  Section A25 & A30 

Non-stocked diameters are also available. Follow the examples shown below.

Metric	38 series, T-A (1 series), 42.15 mm	Part No. = V3801D-42.15
Inch	38 series, T-A (1 series), 1.6790"	Part No. = V3801D-1.6790

 Wear pads sold in multiples of 2 | Wear pad screws sold in multiples of 4
 IC inserts sold in multiples of 2 | Insert screws sold in multiples of 10

A50: 24

www.alliedmachine.com | +44 (0) 1384 400 900 | enquiries.eu@alliedmachine.com

A DRILLING

B BORING

C REAMING

D BURISHING

E THREADING

X SPECIALS

APX Drill Holders

89 Series | Diameter Range: 89.00 mm - 94.99 mm (3.504" - 3.740")

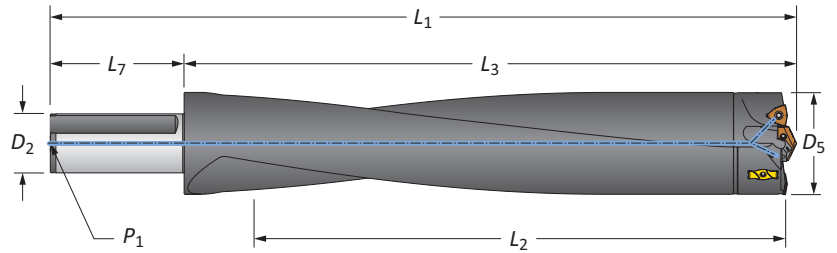

Straight Shank

	Length	D ₅	Body			Shank			Part No.
			L ₂	L ₃	L ₁	L ₇	D ₂	P ₁	
m	3xD	89.00 - 94.99	275.79	333.60	413.59	80.00	50.00	1/4 BSPT	W8903H-50FM
	5xD	89.00 - 94.99	475.01	523.70	603.71	80.00	50.00	1/4 BSPT	W8905H-50FM
	8xD	89.00 - 94.99	701.80	750.29	830.30	80.00	50.00	1/4 BSPT	⚠ W8908H-50FM
i	3xD	3.504 - 3.740	10-7/8	13-1/8	17-5/8	4-1/2	2	1/4 NPT	W8903H-200F
	5xD	3.504 - 3.740	18-5/8	20-5/8	25-1/8	4-1/2	2	1/4 NPT	W8905H-200F
	8xD	3.504 - 3.740	27-5/8	29-35/64	34-3/64	4-1/2	2	1/4 NPT	⚠ W8908H-200F

*Thread to BSP and ISO 7-1

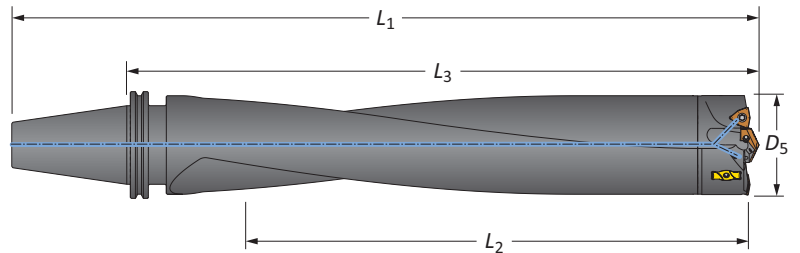

CV50 Shank

	Length	D ₅		Body			Shank	Part No.
		mm	inch	L ₂	L ₃	L ₁		
i	3xD	89.00 - 94.99	3.504 - 3.740	10-7/8	14-33/64	18-33/64	CV50	W8903H-CV50
	5xD	89.00 - 94.99	3.504 - 3.740	18-5/8	22	26	CV50	W8905H-CV50
	8xD	89.00 - 94.99	3.504 - 3.740	26-3/4	30-1/32	34-1/32	CV50	⚠ W8908H-CV50

Connection Accessories

Mounting Screw	Mounting Screw Bit	Admissible Tightening Torque*
78027-IP30-1	8IP-30B	2825 N-cm (250 in-lb)

*Tightening torques are calculated with a friction coefficient of $\mu = 0.14$ and develop 90% of ultimate yield strength

⚠ WARNING Refer to Speed and Feed charts for recommended adjustments to speeds and feeds. Refer to page A50: 30 for deep hole drilling guidelines in this section of the catalogue. Visit www.alliedmachine.com/DeepHoleGuidelines for the most up-to-date information and procedures. Factory technical assistance is available for your specific applications through our Application Engineering Team.
email: engineering.eu@alliedmachine.com

m = Metric (mm)
i = Imperial (in)

Mounting screws sold in multiples of 4

95

 DRILLING | APX™ Drill: Deep Hole / Large Diameter Replaceable Insert Drilling System

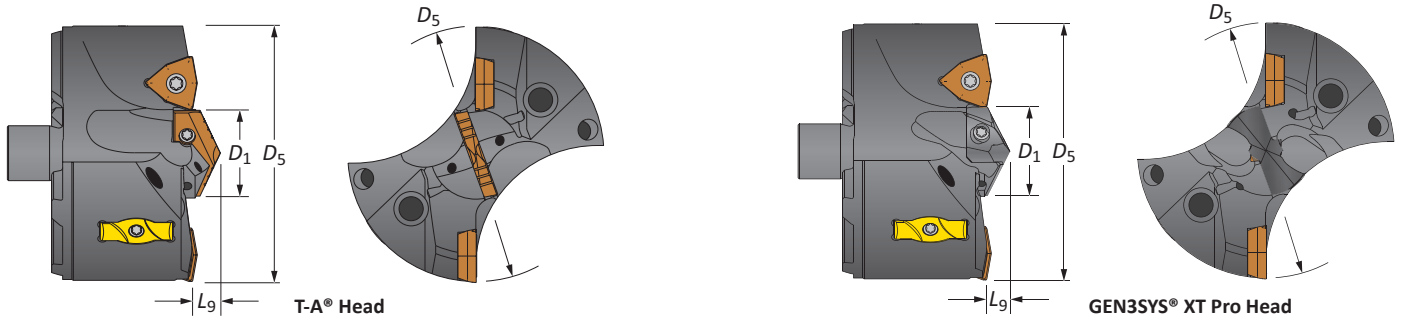

APX Drill Heads

95 Series | Diameter Range: 95.00 mm - 101.60 mm (3.740" - 4.000")





T-A® Head **GEN3SYS® XT Pro Head**

Heads

Head					T-A Head				GEN3SYS XT Pro Head				
D_5 metric	D_5 inch	D_5 fractional	D_1	L_9	Part No.	Pilot Series			Part No.	Pilot Series		IC Insert Size	
												metric	inch
95.25	3.750	3-3/4	35.00	11.51	V9502S-0324	2	TA#2-35.00	1C12H-35-TC	V9532S-0324	32	XT#32-35.00	14.29	9/16
96.00	3.780	-	35.00	11.51	V9502S-96	2	TA#2-35.00	1C12H-35-TC	V9532S-96	32	XT#32-35.00	14.29	9/16
96.84	3.813	3-13/16	35.00	11.51	V9502S-0326	2	TA#2-35.00	1C12H-35-TC	V9532S-0326	32	XT#32-35.00	14.29	9/16
98.00	3.858	-	35.00	11.51	V9502S-98	2	TA#2-35.00	1C12H-35-TC	V9532S-98	32	XT#32-35.00	14.29	9/16
98.43	3.875	3-7/8	35.00	11.51	V9502S-0328	2	TA#2-35.00	1C12H-35-TC	V9532S-0328	32	XT#32-35.00	14.29	9/16
100.00	3.937	-	35.00	11.51	V9502S-100	2	TA#2-35.00	1C12H-35-TC	V9532S-100	32	XT#32-35.00	14.29	9/16
100.01	3.936	3-15/16	35.00	11.51	V9502S-0330	2	TA#2-35.00	1C12H-35-TC	V9532S-0330	32	XT#32-35.00	14.29	9/16
101.60	4.000	4	35.00	11.51	V9502S-0400	2	TA#2-35.00	1C12H-35-TC	V9532S-0400	32	XT#32-35.00	14.29	9/16

#Denotes ISO material/geometry (P= steel, K= cast iron, N= non-ferrous)

IC Inserts

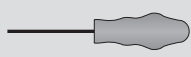
Coating	Size		Grade	Geometry	 Part No.	 Insert Screw	 Insert Driver	Admissible Tightening Torque*
	metric	inch						
AM300®	14.29	9/16	P35 (C5)	Standard	OP-090608-PW	75014-IP20-1	8IP-20	1370 N-cm (121.0 in-lbs)
AM300®	14.29	9/16	K35 (C1)	Standard	OP-090608-1PW	75014-IP20-1	8IP-20	1370 N-cm (121.0 in-lbs)
AM300®	14.29	9/16	K25 (C2)	Standard	OP-090608-2PW	75014-IP20-1	8IP-20	1370 N-cm (121.0 in-lbs)
AM300®	14.29	9/16	P35 (C5)	High Rake	OP-090608-PWHR	75014-IP20-1	8IP-20	1370 N-cm (121.0 in-lbs)

 *Tightening torques are calculated with a friction coefficient of $\mu = 0.14$ and develop 90% of ultimate yield strength

Wear Pads

 Part No.	 Wear Pad Screw	 Wear Pad Driver	Admissible Tightening Torque*
WP7095	7358-IP10-1	8IP-10	300 N-cm (27.0 in-lbs)

 *Tightening torques are calculated with a friction coefficient of $\mu = 0.14$ and develop 90% of ultimate yield strength

Pilot Accessories

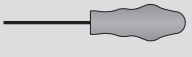
Pilot Style	Series	 Insert Screws	 Insert Driver	Admissible Tightening Torque*
T-A	2	7495-IP15-1	8IP-15	690 N-cm (61.0 in-lbs)
GEN3SYS	32	7495-IP15-1	8IP-15	690 N-cm (61.0 in-lbs)

 *Tightening torques are calculated with a friction coefficient of $\mu = 0.14$ and develop 90% of ultimate yield strength

Key on A50-1

A50: 28 - 29



A50: 2 - 5



Section A20



Section A25 & A30



Non-stocked diameters are also available. Follow the examples shown below.

Metric	38 series, T-A (1 series), 42.15 mm	Part No. = V3801D-42.15
Inch	38 series, T-A (1 series), 1.6790"	Part No. = V3801D-1.6790

 Wear pads sold in multiples of 2 | Wear pad screws sold in multiples of 4
 IC inserts sold in multiples of 2 | Insert screws sold in multiples of 10

A50: 26

www.alliedmachine.com | +44 (0) 1384 400 900 | enquiries.eu@alliedmachine.com

APX Drill Holders

95 Series | Diameter Range: 95.00 mm - 101.60 mm (3.740" - 4.000")

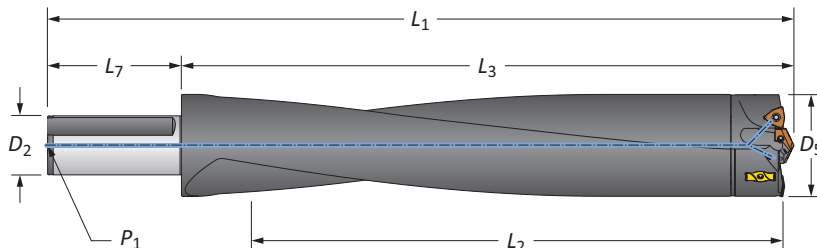

Straight Shank

	Length	D ₅	Body			Shank			Part No.
			L ₂	L ₃	L ₁	L ₇	D ₂	P ₁	
m	3xD	95.00 - 101.60	302.01	362.79	442.80	80.00	50.00	1/4 BSPT	W9503H-50FM
	5xD	95.00 - 101.60	508.00	566.19	646.20	80.00	50.00	1/4 BSPT	W9505H-50FM
	8xD	95.00 - 101.60	699.00	756.69	836.70	80.00	50.00	1/4 BSPT	⚠ W9508H-50FM
i	3xD	3.740 - 4.000	11-7/8	14-9/32	18-25/32	4-1/2	2	1/4 NPT	W9503H-200F
	5xD	3.740 - 4.000	20	22-19/64	26-51/64	4-1/2	2	1/4 NPT	W9505H-200F
	8xD	3.740 - 4.000	27-1/2	29-51/64	34-19/64	4-1/2	2	1/4 NPT	⚠ W9508H-200F

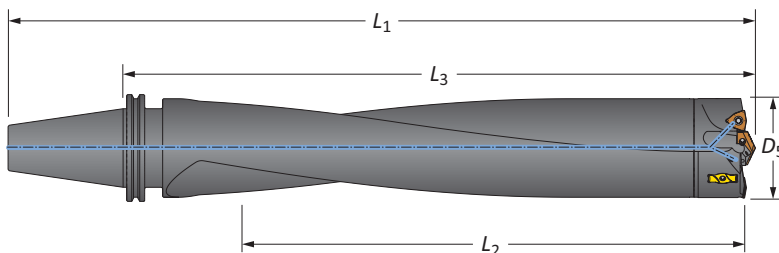

CV50 Shank

	Length	D ₅		Body			Shank	Part No.
		mm	inch	L ₂	L ₃	L ₁		
i	3xD	95.00 - 101.60	3.740 - 4.000	11-7/8	15-43/64	19-43/64	CV50	W9503H-CV50
	5xD	95.00 - 101.60	3.740 - 4.000	20	23-43/64	27-43/64	CV50	W9505H-CV50
	8xD	95.00 - 101.60	3.740 - 4.000	26-5/8	30-9/32	34-9/32	CV50	⚠ W9508H-CV50

Connection Accessories

Mounting Screw	Mounting Screw Bit	Admissible Tightening Torque*
78027-IP30-1	8IP-30B	2825 N-cm (250 in-lb)

*Tightening torques are calculated with a friction coefficient of $\mu = 0.14$ and develop 90% of ultimate yield strength

⚠ WARNING Refer to Speed and Feed charts for recommended adjustments to speeds and feeds. Refer to page A50: 30 for deep hole drilling guidelines in this section of the catalogue. Visit www.alliedmachine.com/DeepHoleGuidelines for the most up-to-date information and procedures. Factory technical assistance is available for your specific applications through our Application Engineering Team.
email: engineering.eu@alliedmachine.com

m = Metric (mm)
i = Imperial (in)

Mounting screws sold in multiples of 4

A DRILLING
B BORING
C REAMING
D BURNISHING
E THREADING
X SPECIALS

Recommended Drilling Data | Metric (mm)

ISO	Material	Hardness (BHN)	Feed Rate (mm/rev) by Diameter								
			Outboard Insert		7.94 IC	9.52 IC	12.70 IC	14.29 IC	9.52 IC	12.70 IC	14.29 IC
			Series		33	38 - 44	44 - 51	51 - 63	70	76 - 83	89 - 95
			Speed (M/min)	Pilot Style	33.00 mm - 37.99 mm	38.00 mm - 47.88 mm	47.89 mm - 56.13 mm	56.14 mm - 69.99 mm	70.00 mm - 75.99 mm	76.00 mm - 88.99 mm	89.00 mm - 101.60 mm
P	Free-Machining Steel 1118, 1215, 12L14, etc.	100 - 250	137 - 229	T-A/GEN3SYS	0.15 - 0.28	0.18 - 0.30	0.23 - 0.30	0.23 - 0.30	0.15 - 0.25	0.18 - 0.28	0.18 - 0.30
	Low-Carbon Steel 1010, 1020, 1025, 1522, 1144, etc.	85 - 275	137 - 229	T-A/GEN3SYS	0.15 - 0.28	0.18 - 0.30	0.23 - 0.30	0.23 - 0.30	0.15 - 0.25	0.18 - 0.28	0.18 - 0.30
	Medium-Carbon Steel 1030, 1040, 1050, 1527, 1140, 1151, etc.	125 - 325	137 - 229	T-A/GEN3SYS	0.15 - 0.28	0.18 - 0.30	0.23 - 0.30	0.23 - 0.30	0.15 - 0.25	0.18 - 0.28	0.18 - 0.30
	Alloy Steel 4140, 5140, 8640, etc.	125 - 375	122 - 213	T-A/GEN3SYS	0.13 - 0.18	0.13 - 0.23	0.18 - 0.25	0.18 - 0.28	0.13 - 0.23	0.15 - 0.25	0.15 - 0.25
	High-Strength Alloy 4340, 4330V, 300M, etc.	225 - 400	91 - 152	T-A/GEN3SYS	0.13 - 0.15	0.13 - 0.18	0.13 - 0.20	0.15 - 0.23	0.13 - 0.18	0.13 - 0.20	0.15 - 0.20
	Structural Steel A36, A285, A516, etc.	100 - 350	137 - 229	T-A/GEN3SYS	0.15 - 0.20	0.18 - 0.23	0.20 - 0.25	0.23 - 0.28	0.13 - 0.23	0.15 - 0.25	0.15 - 0.25
	Tool Steel H-13, H-21, A-4, O-2, S-3, etc.	150 - 250	91 - 152	T-A/GEN3SYS	0.13 - 0.15	0.13 - 0.18	0.18 - 0.23	0.20 - 0.25	0.13 - 0.18	0.15 - 0.23	0.18 - 0.25
S	High-Temp Alloy Hastelloy B, Inconel 600, etc.	140 - 310	61 - 122	T-A	0.10 - 0.13	0.10 - 0.18	0.15 - 0.23	0.18 - 0.23	0.10 - 0.15	0.13 - 0.18	0.13 - 0.18
	Titanium Alloy	140 - 310	91 - 152	T-A	0.13 - 0.18	0.15 - 0.20	0.18 - 0.23	0.20 - 0.25	0.10 - 0.15	0.13 - 0.18	0.13 - 0.18
	Aerospace Alloy S82	185 - 350	122 - 183	T-A/GEN3SYS	0.10 - 0.15	0.13 - 0.18	0.15 - 0.20	0.15 - 0.20	0.10 - 0.15	0.13 - 0.18	0.13 - 0.18
M	Stainless Steel 400 Series 416, 420, etc.	185 - 350	91 - 152	T-A/GEN3SYS	0.15 - 0.20	0.18 - 0.23	0.20 - 0.25	0.23 - 0.28	0.13 - 0.18	0.18 - 0.23	0.18 - 0.25
	Stainless Steel 300 Series 304, 316, 17-4PH, etc.	135 - 275	91 - 152	T-A/GEN3SYS	0.13 - 0.18	0.15 - 0.20	0.18 - 0.23	0.20 - 0.25	0.10 - 0.20	0.15 - 0.25	0.15 - 0.25
	Super Duplex Stainless Steel	135 - 275	76 - 137	T-A/GEN3SYS	0.10 - 0.15	0.13 - 0.18	0.18 - 0.23	0.18 - 0.23	0.10 - 0.18	0.15 - 0.23	0.18 - 0.25
H	Wear Plate Hardox, AR400, T-1, etc.	400 - 600	91 - 152	T-A	0.07 - 0.13	0.10 - 0.15	0.15 - 0.20	0.18 - 0.23	0.08 - 0.13	0.10 - 0.15	0.10 - 0.15
	Hardened Steel	300 - 500	91 - 152	T-A	0.10 - 0.13	0.13 - 0.15	0.15 - 0.20	0.15 - 0.20	0.08 - 0.13	0.10 - 0.20	0.10 - 0.20
K	Nodular, Grey, Ductile Cast Iron	120 - 320	152 - 244	T-A/GEN3SYS	0.13 - 0.23	0.15 - 0.25	0.20 - 0.30	0.25 - 0.30	0.20 - 0.25	0.23 - 0.28	0.25 - 0.30
N	Cast Aluminium	30 - 180	183 - 244	T-A/GEN3SYS	0.23 - 0.30	0.25 - 0.36	0.30 - 0.40	0.30 - 0.40	0.15 - 0.23	0.20 - 0.28	0.20 - 0.30
	Wrought Aluminium	30 - 180	183 - 244	T-A/GEN3SYS	0.18 - 0.28	0.20 - 0.30	0.25 - 0.36	0.25 - 0.36	0.15 - 0.23	0.20 - 0.28	0.20 - 0.30
	Aluminium Bronze	100 - 250	123 - 213	T-A/GEN3SYS	0.13 - 0.18	0.13 - 0.20	0.18 - 0.25	0.23 - 0.28	0.15 - 0.23	0.18 - 0.25	0.20 - 0.30
	Brass	30 - 100	244	T-A/GEN3SYS	0.15 - 0.20	0.18 - 0.23	0.20 - 0.25	0.23 - 0.30	0.15 - 0.20	0.18 - 0.23	0.20 - 0.25
	Copper	60	213	T-A/GEN3SYS	0.05 - 0.13	0.08 - 0.15	0.15 - 0.20	0.20 - 0.25	0.08 - 0.15	0.15 - 0.20	0.15 - 0.20

Coolant Recommendations

Series	Pressure (BAR)	Flow Rate (LPM)
33	24	38
38	21	38
44	19	45
51	17	68
57	16	76
63	14	83
70	10	95
76	7	106
83	7	114
89	7	125
95	7	125

Calculations

Value	Formula
M/min	RPM • 0.003 • Diameter
RPM	(m/min • 318.47) / Diameter
mm/min	RPM • mm/rev

IMPORTANT: The speeds and feeds listed above are a general starting point for all applications. Refer to the Coolant Recommendation charts for coolant requirements to run at the recommended speeds and feeds. Factory technical assistance is also available through our Application Engineering Team. *email: engineering.eu@alliedmachine.com*

IMPORTANT: The coolant pressure and flow rate recommendations above represent a good approximation to obtain optimum tool life and chip evacuation at Allied Machine recommended speeds and feeds. If lower coolant capabilities exist in a drilling application, the APX Drilling System will still function at reduced penetration rates. Contact our Application Engineering department for a more specific recommendation of coolant requirements and/or speeds and feeds.

⚠ WARNING Tool failure can cause serious injury. To prevent: For APX holders 8xD or longer, do not rotate tool more than 50 RPM unless it is engaged with workpiece or fixture. Refer to page A50: 30 for Deep Hole Drilling Guidelines in this section of the catalogue. Visit www.alliedmachine.com/DeepHoleGuidelines for the most up-to-date information and procedures. Factory technical assistance is also available for your specific applications.

Recommended Drilling Data | Imperial (inch)

ISO	Material	Hardness (BHN)	Feed Rate (IPR) by Diameter								
			Outboard Insert		5/16" IC	3/8" IC	1/2" IC	9/16" IC	3/8" IC	1/2" IC	9/16" IC
			Series		33	38 - 44	44 - 51	51 - 63	70	76 - 83	89 - 95
			Speed (SFM)	Pilot Style	1.299" - 1.495"	1.496" - 1.885"	1.886" - 2.210"	2.211" - 2.755"	2.756" - 2.992"	2.992" - 3.503"	3.504" - 4.000"
P	Free-Machining Steel 1118, 1215, 12L14, etc.	100 - 250	450 - 750	T-A/GEN3SYS	0.006 - 0.011	0.007 - 0.012	0.009 - 0.012	0.009 - 0.012	0.006 - 0.010	0.007 - 0.011	0.007 - 0.012
	Low-Carbon Steel 1010, 1020, 1025, 1522, 1144, etc.	85 - 275	450 - 750	T-A/GEN3SYS	0.006 - 0.011	0.007 - 0.012	0.009 - 0.012	0.009 - 0.012	0.006 - 0.010	0.007 - 0.011	0.007 - 0.012
	Medium-Carbon Steel 1030, 1040, 1050, 1527, 1140, 1151, etc.	125 - 325	450 - 750	T-A/GEN3SYS	0.006 - 0.011	0.007 - 0.012	0.009 - 0.012	0.009 - 0.012	0.006 - 0.010	0.007 - 0.011	0.007 - 0.012
	Alloy Steel 4140, 5140, 8640, etc.	125 - 375	400 - 700	T-A/GEN3SYS	0.005 - 0.007	0.005 - 0.009	0.007 - 0.010	0.007 - 0.011	0.005 - 0.009	0.006 - 0.010	0.006 - 0.010
	High-Strength Alloy 4340, 4330V, 300M, etc.	225 - 400	300 - 500	T-A/GEN3SYS	0.005 - 0.006	0.005 - 0.007	0.005 - 0.008	0.006 - 0.009	0.005 - 0.007	0.005 - 0.008	0.006 - 0.008
	Structural Steel A36, A285, A516, etc.	100 - 350	450 - 750	T-A/GEN3SYS	0.006 - 0.008	0.007 - 0.009	0.008 - 0.010	0.009 - 0.011	0.005 - 0.009	0.006 - 0.010	0.007 - 0.010
	Tool Steel H-13, H-21, A-4, O-2, S-3, etc.	150 - 250	300 - 500	T-A/GEN3SYS	0.005 - 0.006	0.005 - 0.007	0.007 - 0.009	0.008 - 0.010	0.005 - 0.007	0.006 - 0.009	0.007 - 0.010
S	High-Temp Alloy Hastelloy B, Inconel 600, etc.	140 - 310	200 - 400	T-A	0.004 - 0.005	0.004 - 0.007	0.006 - 0.009	0.007 - 0.009	0.004 - 0.006	0.005 - 0.007	0.005 - 0.007
	Titanium Alloy	140 - 310	300 - 500	T-A	0.005 - 0.007	0.006 - 0.008	0.007 - 0.009	0.008 - 0.010	0.004 - 0.006	0.005 - 0.007	0.005 - 0.007
	Aerospace Alloy S82	185 - 350	400 - 600	T-A/GEN3SYS	0.004 - 0.006	0.005 - 0.007	0.006 - 0.008	0.006 - 0.008	0.004 - 0.006	0.005 - 0.007	0.005 - 0.007
M	Stainless Steel 400 Series 416, 420, etc.	185 - 350	300 - 500	T-A/GEN3SYS	0.006 - 0.008	0.007 - 0.009	0.008 - 0.010	0.009 - 0.011	0.005 - 0.007	0.007 - 0.009	0.007 - 0.010
	Stainless Steel 300 Series 304, 316, 17-4PH, etc.	135 - 275	300 - 500	T-A/GEN3SYS	0.005 - 0.007	0.006 - 0.008	0.007 - 0.009	0.008 - 0.010	0.004 - 0.008	0.006 - 0.010	0.006 - 0.010
	Super Duplex Stainless Steel	135 - 275	250 - 450	T-A/GEN3SYS	0.004 - 0.006	0.005 - 0.007	0.007 - 0.009	0.007 - 0.009	0.004 - 0.007	0.006 - 0.009	0.007 - 0.010
H	Wear Plate Hardox, AR400, T-1, etc.	400 - 600	300 - 500	T-A	0.003 - 0.005	0.004 - 0.006	0.006 - 0.008	0.007 - 0.009	0.003 - 0.005	0.004 - 0.006	0.004 - 0.006
	Hardened Steel	300 - 500	300 - 500	T-A	0.004 - 0.005	0.005 - 0.006	0.006 - 0.008	0.006 - 0.008	0.003 - 0.005	0.004 - 0.006	0.004 - 0.006
K	Nodular, Grey, Ductile Cast Iron	120 - 320	500 - 800	T-A/GEN3SYS	0.005 - 0.009	0.006 - 0.010	0.008 - 0.012	0.010 - 0.012	0.008 - 0.010	0.009 - 0.011	0.010 - 0.012
N	Cast Aluminium	30 - 180	600 - 800	T-A/GEN3SYS	0.009 - 0.012	0.010 - 0.014	0.012 - 0.016	0.012 - 0.016	0.006 - 0.009	0.008 - 0.011	0.008 - 0.012
	Wrought Aluminium	30 - 180	600 - 800	T-A/GEN3SYS	0.007 - 0.011	0.008 - 0.012	0.010 - 0.014	0.010 - 0.014	0.006 - 0.009	0.008 - 0.011	0.008 - 0.012
	Aluminium Bronze	100 - 250	400 - 700	T-A/GEN3SYS	0.005 - 0.007	0.005 - 0.008	0.007 - 0.010	0.009 - 0.011	0.006 - 0.009	0.007 - 0.010	0.008 - 0.012
	Brass	30 - 100	800	T-A/GEN3SYS	0.006 - 0.008	0.007 - 0.009	0.008 - 0.010	0.009 - 0.012	0.006 - 0.008	0.007 - 0.009	0.008 - 0.012
	Copper	60	700	T-A/GEN3SYS	0.002 - 0.005	0.003 - 0.006	0.006 - 0.008	0.008 - 0.010	0.006 - 0.008	0.006 - 0.008	0.006 - 0.008

Coolant Recommendations

Series	Pressure (PSI)	Flow Rate (GPM)
33	350	10
38	300	10
44	275	12
51	250	18
57	225	20
63	200	22
70	150	25
76	100	28
83	100	30
89	100	33
95	100	33

Calculations

Value	Formula
SFM	$RPM \cdot 0.262 \cdot \text{Diameter}$
RPM	$(SFM \cdot 3.82) / \text{Diameter}$
IPM	$RPM \cdot \text{IPR}$

IMPORTANT: The speeds and feeds listed above are a general starting point for all applications. Refer to the Coolant Recommendation charts for coolant requirements to run at the recommended speeds and feeds. Factory technical assistance is also available through our Application Engineering Team. *email: engineering.eu@alliedmachine.com*

IMPORTANT: The coolant pressure and flow rate recommendations above represent a good approximation to obtain optimum tool life and chip evacuation at Allied Machine recommended speeds and feeds. If lower coolant capabilities exist in a drilling application, the APX Drilling System will still function at reduced penetration rates. Contact our Application Engineering department for a more specific recommendation of coolant requirements and/or speeds and feeds.

⚠ WARNING Tool failure can cause serious injury. To prevent: For APX holders 8xD or longer, do not rotate tool more than 50 RPM unless it is engaged with workpiece or fixture. Refer to page A50: 30 for Deep Hole Drilling Guidelines in this section of the catalogue. Visit www.alliedmachine.com/DeepHoleGuidelines for the most up-to-date information and procedures. Factory technical assistance is also available for your specific applications.

A
DRILLING
B
BORING
C
REAMING
D
BURNISHING
E
THREADING
X
SPECIALS



Deep Hole Drilling Guidelines

A
DRILLING

1. Approach
50 RPM max
300 mm/min (12 IPM)

Feed the longer drill within 1.5 mm (1/16") short of the workpiece at a **maximum of 50 RPM** and 300 mm/min (12 IPM) feed rate.

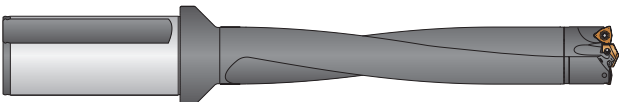
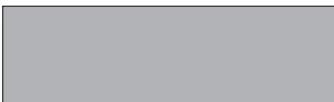
Coolant OFF



B
BORING

2. Feed-in
Speed at 75% of recommended start
Feed at 50% of recommended start

Drill 19.05 mm (3/4") deep at 75% recommended speed and 50% recommended feed to establish the hole.

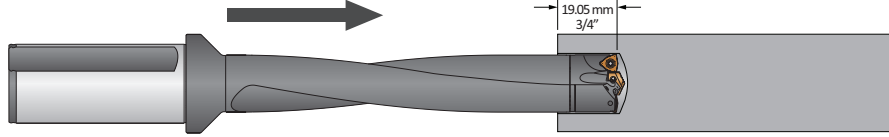

Coolant ON

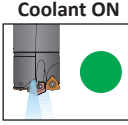

C
REAMING

3. Deep Hole Drilling - Blind
100% RPM
100% mm/rev (IPR)

Drill to full depth at recommended speed and feed for longer drills (according to Allied Machine speed and feed charts).
***No peck cycle recommended.**

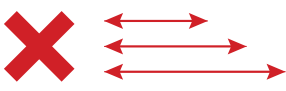
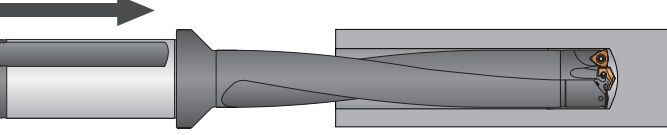
Coolant ON

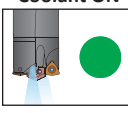

D
BURNISHING

4. Deep Hole Drilling - at Breakout
50% RPM
100% mm/rev (IPR)

***For through holes only:**
Reduce speed by 50% prior to breakout.
Do not breakout more than 3 mm (1/8") past the full diameter of the drill.

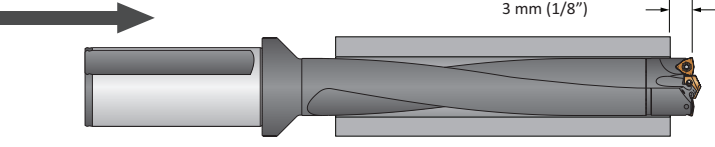

Coolant ON

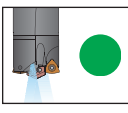

E
THREADING

5. Drill Retract
50 RPM max

Reduce speed to a **maximum of 50 RPM** before retracting from the hole.

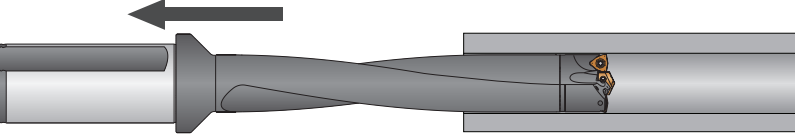

Coolant OFF

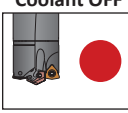

X
SPECIALS

⚠ WARNING Tool failure can cause serious injury. To prevent: NEVER rotate these tool holders more than 50 RPM without proper engagement with a workpiece or fixture. Failure to do so could result in tool failure and/or personal injury. Visit www.alliedmachine.com/DeepHoleGuidelines for the most up-to-date information and procedures. Factory technical assistance is also available for your specific applications.
email: engineering.eu@alliedmachine.com

Warranty Information



Allied Machine & Engineering ("Allied Machine") warrants to original equipment manufacturers, distributors, industrial and commercial users of its products for one year from the original date of sale that each new product manufactured or supplied by Allied Machine shall be free from defects in material and workmanship.

Allied Machine's sole and exclusive obligation under this warranty is limited to, at its option, without additional charge, replacing or repairing this product or issuing a credit. For this warranty to be applied, the product must be returned freight prepaid to the plant designated by an Allied Machine representative and which, upon inspection, is determined by Allied Machine to be defective in material and workmanship.

Complete information as to operating conditions, machine, setup, and the application of cutting fluid should accompany any product returned for inspection. This warranty shall not apply to any Allied Machine products which have been subjected to misuse, abuse, improper operating conditions, improper machine setup or improper application of cutting fluid or which have been repaired or altered if such repair or alteration, in the judgement of Allied Machine, would adversely affect the performance of the product.

THIS WARRANTY IS IN LIEU OF ALL OTHER WARRANTIES, EXPRESS OR IMPLIED, INCLUDING ANY IMPLIED WARRANTY OF MERCHANTABILITY OR FITNESS FOR A PARTICULAR PURPOSE. Allied Machine shall have no liability or responsibility for any claim, whether in contract, tort or otherwise, for any loss or damage arising out of, connected with, or resulting from the manufacture, sale, delivery or use of any product sold hereunder, in excess of the cost of replacement or repair as provided herein.

Allied Machine shall not be liable in contract or in tort (including, without limitation, negligence, strict liability or otherwise) for economic losses of any kind or for any special, incidental, indirect, consequential, punitive or exemplary damages arising in any way out of the performance of, or failure to perform this agreement.

ALL PRICES, DELIVERIES, DESIGNS, AND MATERIALS ARE SUBJECT TO CHANGE WITHOUT NOTICE.



Allied Machine & Engineering Co. Europe Ltd. is registered to ISO 9001:2015 by bsi.



Allied Machine & Engineering is registered to ISO 9001:2015 by DQS



Wohlhaupter GmbH is registered to ISO 9001:2015 by QA TECHNIC

Europe

Allied Machine & Engineering Co. (Europe) Ltd.

93 Vantage Point
Pensnett Estate
Kingswinford
West Midlands
DY6 7FR England

Phone:

+44 (0) 1384.400900

Wohlhaupter GmbH

Maybachstrasse 4
Postfach 1264
72636 Frickenhausen
Germany

Phone:

+49 (0) 7022.408.0

Fax:

+49 (0) 7022.408.212

United States

Allied Machine & Engineering

120 Deeds Drive
Dover OH 44622
United States

Phone:

+1.330.343.4283

Fax:

+1.330.602.3400

Toll Free USA and Canada:

800.321.5537

Toll Free USA and Canada:

800.223.5140

Allied Machine & Engineering

485 W Third Street
Dover OH 44622
United States

Phone:

+1.330.343.4283

Fax:

+1.330.364.7666
(Engineering Dept.)

Toll Free USA and Canada:

800.321.5537

Asia

Wohlhaupter India Pvt. Ltd.

B-23, 3rd Floor
B Block Community Centre
Janakpuri, New Delhi - 110058
India

Phone:

+91 (0) 11.41827044

Your local Allied Machine representative:

www.alliedmachine.com

Allied Machine & Engineering Co. (Europe) Ltd is registered to **ISO 9001:2015** by bsi.

Allied Machine & Engineering is registered to **ISO 9001:2015** by DQS

Wohlhaupter GmbH is registered to **ISO 9001:2015** by QTA TECHNIC

